

**ACE rotary dampers** are maintenance-free and ready to install. The damping direction of the rotary dampers with continuous rotation can be clockwise, counter clockwise, or in both directions. The outer body is either of metal or plastic. Rotary dampers with continuous rotation ensure the controlled opening and closing of small hoods, compartments and drawers. They can damp directly at the rotation point or linearly by means of a rack and pinion, in order to produce a smooth and even movement. Sensitive components remain unstressed. The harmonious gentle movement process enhances the quality and value of the product. Plastic racks (modules 0.5 to 1.0) are available for the rotary dampers with pinions. Particularly suitable for flaps, closing hoods, CD-player drawers, vehicle glove compartments, the furniture industry etc.

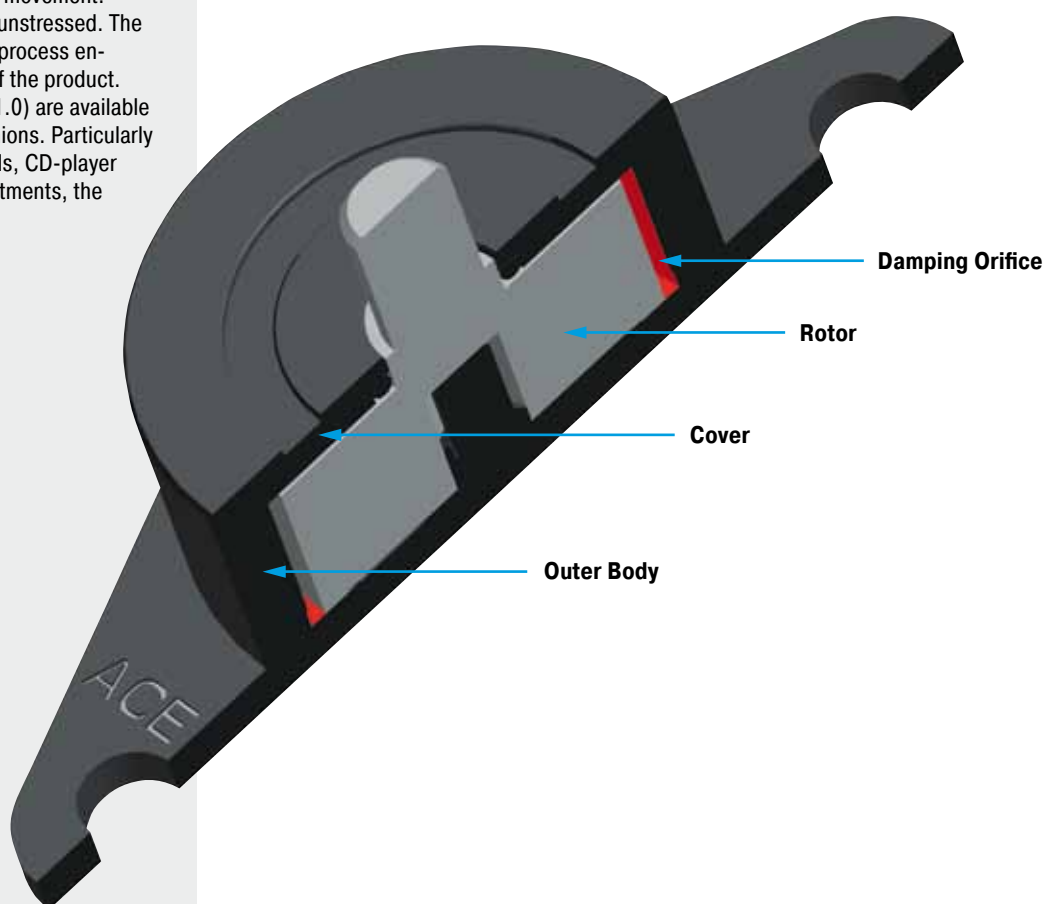

**Function:** In rotary dampers with continuous rotation, a fluid damping is produced by the shearing of thin silicon layers between the surfaces of a rotor and a stator. The damping moment is determined by the viscosity of the fluid and the dimensioning of the throttle gap. The specified damping moments refer to a speed of 20 rpm and an ambient temperature of 23 °C.

**Note:** In general, ACE rotary dampers are tested for a service life of 50 000 cycles. Even after this time, the dampers still produce over approx. 80% of their original damping moment. The service life may be significantly higher or lower, depending on the application. Much higher service lives have however been achieved in practice.



### FRT-E2

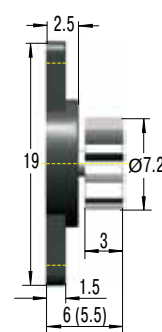
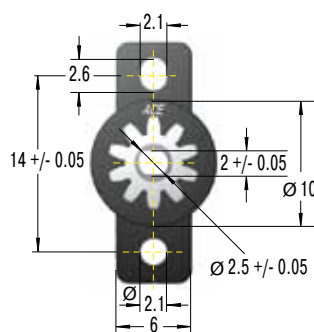
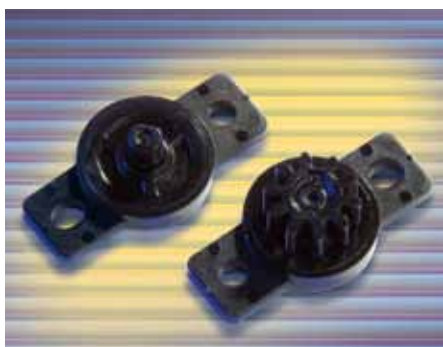

Dims. in ( ) without gear

### Technical Data

**Pressure angle:** 20°  
**Material:** Polycarbonate plastic  
**Tooth:** Involute  
**P.C.D.:** 6 mm  
**No. of teeth:** 10  
**Module:** 1 0.6  
**Operating temperature range:** 0 °C to 50 °C

FRT-E2 (at 23 °C)

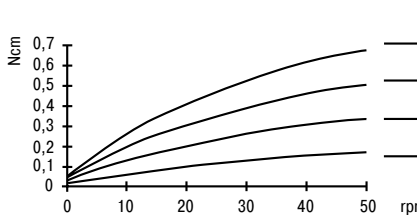

FRT-E2 (at 20 rpm)

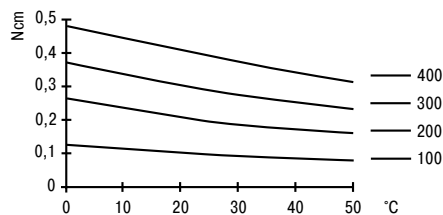

1 A 250 mm long plastic rack is available for use with this part see page 138.

### Damping in both Directions of Rotation

Without Gear	Nominal 20 rpm. 23 °C Damping Torque Ncm
FRT-E2-100	0.10 +/- 0.05
FRT-E2-200	0.20 +/- 0.07
FRT-E2-300	0.30 +/- 0.08
FRT-E2-400	0.40 +/- 0.10

### Damping in both Directions of Rotation

With Gear	Nominal 20 rpm. 23 °C Damping Torque Ncm
FRT-E2-100-G1	0.10 +/- 0.05
FRT-E2-200-G1	0.20 +/- 0.07
FRT-E2-300-G1	0.30 +/- 0.08
FRT-E2-400-G1	0.40 +/- 0.10

### FRT-G2

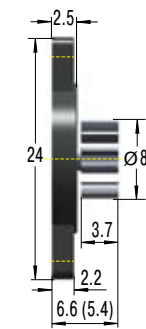
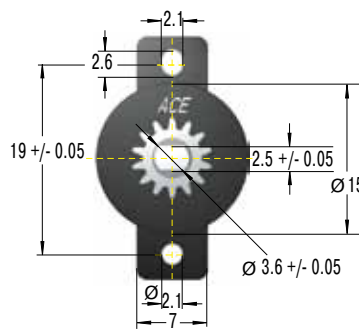

Dims. in ( ) without gear

### Technical Data

**Pressure angle:** 20°  
**Material:** Polycarbonate plastic  
**Tooth:** Involute  
**P.C.D.:** 7 mm  
**No. of teeth:** 14  
**Module:** 1 0.5  
**Operating temperature range:** 0 °C to 50 °C

FRT-G2 (at 23 °C)

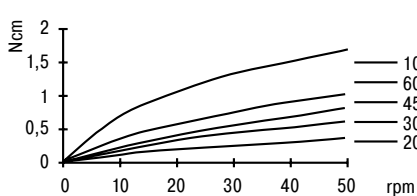

FRT-G2 (at 20 rpm)

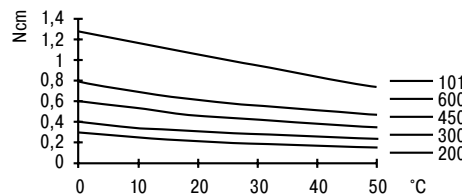

1 A 250 mm long plastic rack is available for use with this part see page 138.

### Damping in both Directions of Rotation

Without Gear	Nominal 20 rpm. 23 °C Damping Torque Ncm
FRT-G2-200	0.20 +/- 0.07
FRT-G2-300	0.30 +/- 0.08
FRT-G2-450	0.45 +/- 0.10
FRT-G2-600	0.60 +/- 0.12
FRT-G2-101	1.00 +/- 0.20

### Damping in both Directions of Rotation

With Gear	Nominal 20 rpm. 23 °C Damping Torque Ncm
FRT-G2-200-G1	0.20 +/- 0.07
FRT-G2-300-G1	0.30 +/- 0.08
FRT-G2-450-G1	0.45 +/- 0.10
FRT-G2-600-G1	0.60 +/- 0.12
FRT-G2-101-G1	1.00 +/- 0.20

#### FRT-C2 and FRN-C2

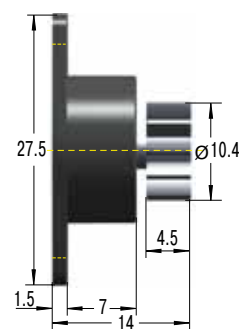
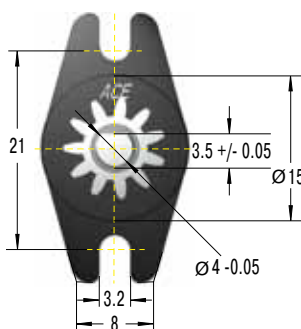

#### Technical Data

**Pressure angle:** 20°  
**Material:** Polycarbonate plastic  
**Tooth:** Involute  
**P.C.D.:** 8.8 mm  
**No. of teeth:** 11  
**Module:** 1 0.8  
**Operating temperature range:** 0 °C to 50 °C

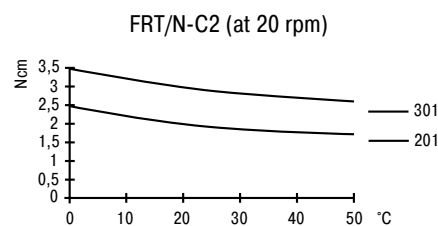
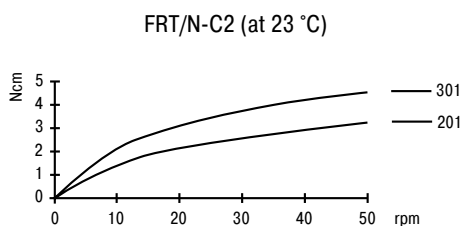

<sup>1</sup> A 170 mm long flexible plastic rack and a 250 mm long rigid rack are available for use with this part see page 138.

Bidirectional Damping	Right-Hand Damping (clockwise)	Left-Hand Damping (anti-clockwise)	Gear	Nominal 20 rpm, 23 °C	
				Damping Torque	Ncm
FRT-C2-201	FRN-C2-R201	FRN-C2-L201	without	2 +/- 0.6	
FRT-C2-201-G1	FRN-C2-R201-G1	FRN-C2-L201-G1	with	2 +/- 0.6	
FRT-C2-301	FRN-C2-R301	FRN-C2-L301	without	3 +/- 0.8	
FRT-C2-301-G1	FRN-C2-R301-G1	FRN-C2-L301-G1	with	3 +/- 0.8	

#### FRT-D2 and FRN-D2

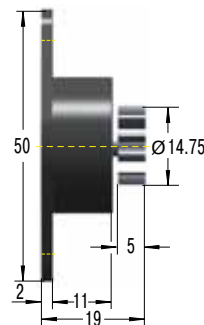
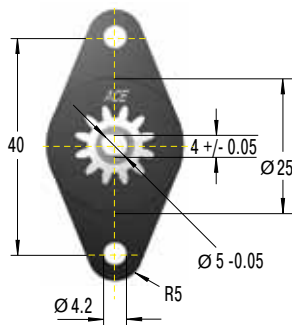

#### Technical Data

**Pressure angle:** 20°  
**Material:** Polycarbonate plastic  
**Tooth:** Involute  
**P.C.D.:** 12 mm  
**No. of teeth:** 12  
**Module:** 1 1.0  
**Operating temperature range:** 0 °C to 50 °C

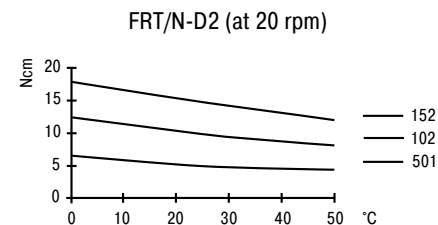
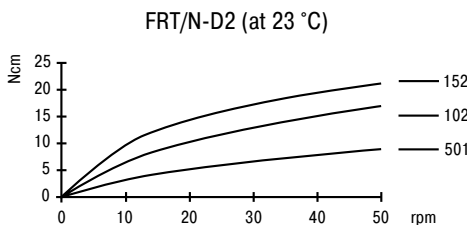

<sup>1</sup> A 250 mm and 500 mm long plastic rack are available for use with this part see page 138.

Bidirectional Damping	Right-Hand Damping (clockwise)	Left-Hand Damping (anti-clockwise)	Gear	Nominal 20 rpm, 23 °C	
				Damping Torque	Ncm
FRT-D2-102	FRN-D2-R102	FRN-D2-L102	without	10 +/- 2	
FRT-D2-102-G1	FRN-D2-R102-G1	FRN-D2-L102-G1	with	10 +/- 2	
FRT-D2-152	FRN-D2-R152	FRN-D2-L152	without	15 +/- 3	
FRT-D2-152-G1	FRN-D2-R152-G1	FRN-D2-L152-G1	with	15 +/- 3	
FRT-D2-501	FRN-D2-R501	FRN-D2-L501	without	5 +/- 1	
FRT-D2-501-G1	FRN-D2-R501-G1	FRN-D2-L501-G1	with	5 +/- 1	

### FRT/FRN-K2 and FRT/FRN-F2

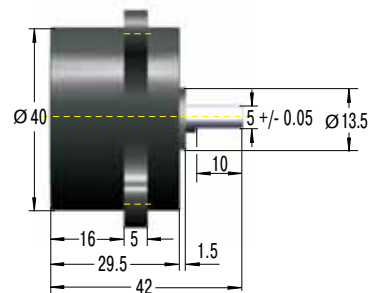
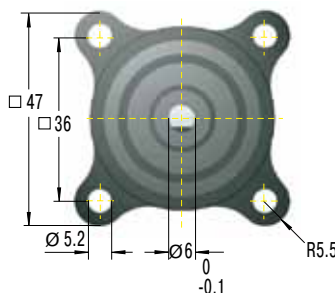

#### Technical Data

**Max. weight:** 0.116 kg  
**Material:** Polycarbonate plastic, steel shaft  
**Operating temperature range:** 0 °C to 50 °C

FRT-K2 and -F2 (at 23 °C)

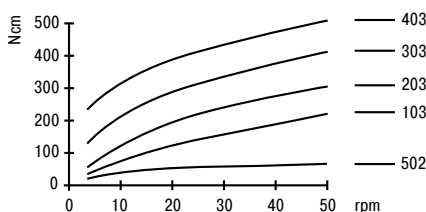

FRT-K2 and -F2 (at 20 rpm)

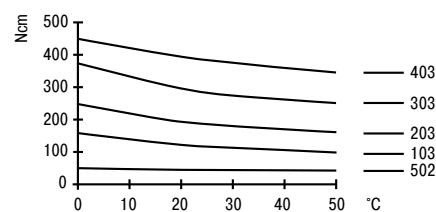

Bidirectional Damping	Right-Hand Damping (clockwise)	Left-Hand Damping (anti-clockwise)	Nominal 20 rpm, 23 °C
			Damping Torque Ncm
FRT-K2-502	FRN-K2-R502	FRN-K2-L502	50 +/- 10
FRT-K2-103	FRN-K2-R103	FRN-K2-L103	100 +/- 20
FRT-F2-203	FRN-F2-R203	FRN-F2-L203	200 +/- 40
FRT-F2-303	-	-	300 +/- 80
FRT-F2-403	-	-	400 +/- 100

### FFD

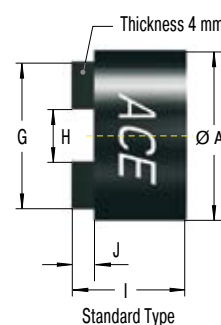
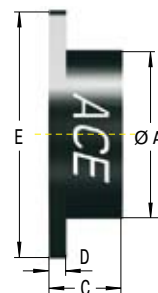
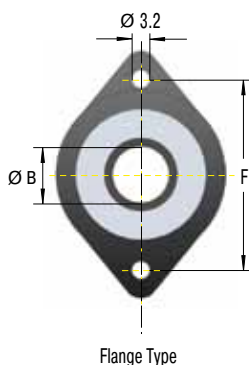
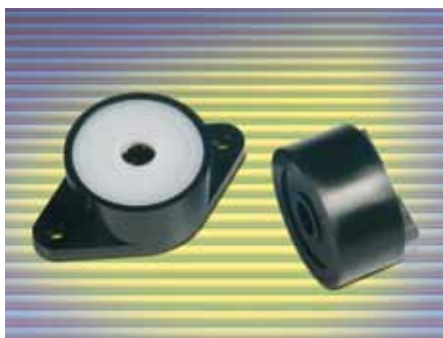

#### Technical Data

**Recommended shaft details:**  $\varnothing^{+0}_{-0,03}$   
**Material:** Polycarbonate plastic  
**Rotational speed max.:** 30 rpm  
**Cycle rate max.:** 13 cycles per minute  
**Operating temperature range:** -10 °C to 60 °C

#### Ordering Example

Friction Damper \_\_\_\_\_  
 Body  $\varnothing$  \_\_\_\_\_  
 Mounting Style (Flange = F, Standard = S) \_\_\_\_\_  
 Damping Option (S or W) \_\_\_\_\_  
 Damping Direction (right = R, left = L) \_\_\_\_\_  
 Damping Torque see chart \_\_\_\_\_

#### FFD-25-FS-L-102

#### Damping Torque

102 = 0.1 Nm  
 502 = 0.5 Nm  
 103 = 1.0 Nm  
 153 = 1.5 Nm  
 203 = 2.0 Nm  
 253 = 2.5 Nm  
 303 = 3.0 Nm

Type	Damping Torque Nm	Damping Option	Dimensions		Flange Type				Standard Type			
			A	B	C	D	E	F	G	H	I	J
FFD-25	0.1/0.5/1.0	Type S	25	6	13	3	42	34	21	6.2	16	4
FFD-28	0.1/0.5/1.0	Type S	28	8	13	3	44	36	24	8.2	16	4
FFD-30	0.1/0.5/1.0/1.5	Type S	30	10	13	3	46	38	26	10.2	16	4
FFD-25	1.0/1.5/2.0	Type W	25	6	19	3	42	34	21	6.2	22	4
FFD-28	1.0/1.5/2.0	Type W	28	8	19	3	44	36	24	8.2	22	4
FFD-30	1.5/2.0/2.5/3.0	Type W	30	10	19	3	46	38	26	10.2	22	4

<sup>1</sup> Type W with bearing on both sides for a higher damping torque.

#### FDT-47 to 70

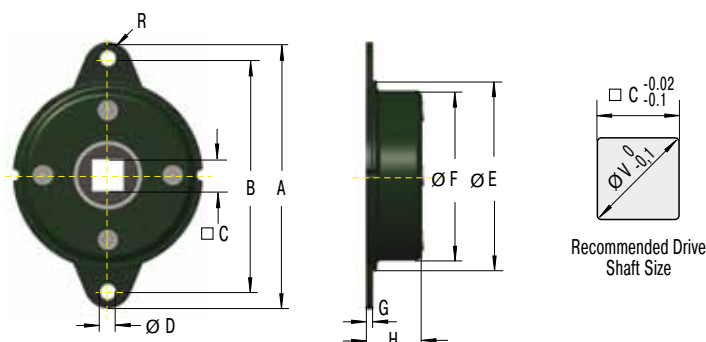

#### Technical Data

**Max. weight:** 0.11 kg  
**Material:** Steel. Output shaft sleeve: Nylon  
**Rotational speed max.:** 50 rpm  
**Cycle rate max.:** 12 cycles per minute  
**Operating temperature range:** -10 °C to 50 °C

FDT (at 23 °C)

FDT (at 20 rpm)

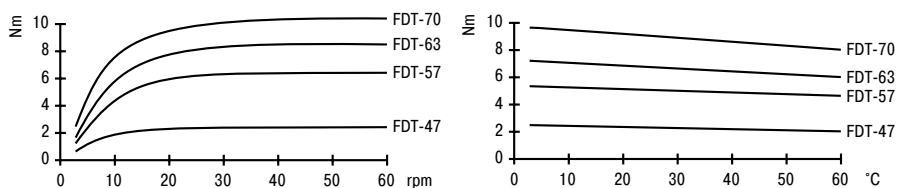

There is no support for the output shaft within the damper structure. External support must be provided for the shaft.

#### Damping in both Directions of Rotation

Type	at 20 rpm, 23 °C Damping Torque Nm	Dimensions									
		A	B	C	D	E	F	G	H	R	V
FDT-47	2.0 +/- 0.3	65	56	8	4.5	47	42.8	1.6	10.3	4.5	10
FDT-57	4.7 +/- 0.5	79	68	10	5.5	57	52.4	1.6	11.2	5.5	13
FDT-63	6.7 +/- 0.7	89	76	12.5	6.5	63	58.6	1.6	11.3	6.5	17
FDT-70	8.7 +/- 0.8	95	82	12.5	6.5	70	65.4	1.6	11.3	6.5	17

#### FDN-47 to 70

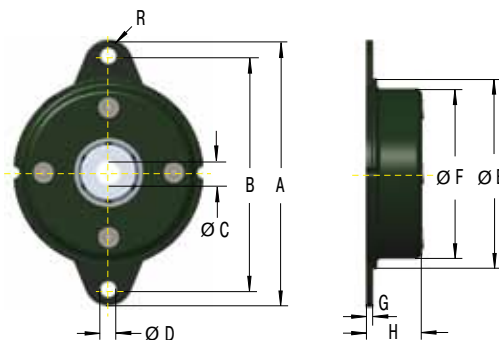

#### Technical Data

**Max. weight:** 0.12 kg  
**Material:** Steel. Output shaft sleeve: Nylon  
**Rotational speed max.:** 50 rpm  
**Cycle rate max.:** 12 cycles per minute  
**Operating temperature range:** -10 °C to 50 °C

There is no support for the output shaft within the damper structure. External support must be provided for the shaft.

#### Recommended shaft details:

for FDN-47:  $\text{Ø } 6^{+0}_{-0.03}$

for FDN-57 to FDN-70:  $\text{Ø } 10^{+0}_{-0.03}$

Hardness > HRC55, surface smoothness  $R_z < 1 \mu\text{m}$

Right-Hand Damping (clockwise)	Left-Hand Damping (anti-clockwise)	at 20 rpm, 23 °C Damping Torque Nm	Dimensions									
			A	B	C	D	E	F	G	H	R	
FDN-47-R	FDN-47-L	2.0 +/- 0.3	65	56	6	4.5	47	42.8	1.6	10.3	4.5	
FDN-57-R	FDN-57-L	5.5 +/- 0.3	79	68	10	5.5	57	52.4	1.6	14	5.5	
FDN-63-R	FDN-63-L	8.5 +/- 0.8	89	76	10	6.5	63	58.6	1.6	13.9	6.5	
FDN-70-R	FDN-70-L	10.0 +/- 1.0	95	82	10	6.5	70	65.4	1.6	13	6.5	

**ACE rotary dampers** are maintenance-free and ready to install. The damping direction of the rotary dampers with partial rotation angle can have clockwise or counter clockwise damping. The outer bodies are of plastic or die-cast zinc. Rotary dampers with partial rotation angle allow the controlled opening and closing of small hoods, covers or flaps. They can be fitted directly at the point of rotation, in order to produce a smooth and even movement. Sensitive components remain unstressed. The harmonious gentle movement process enhances the quality and value of the product. Particularly suitable for flaps, covers and covering hoods for such items as printers or photocopiers, toilet seat covers, the furniture industry etc.

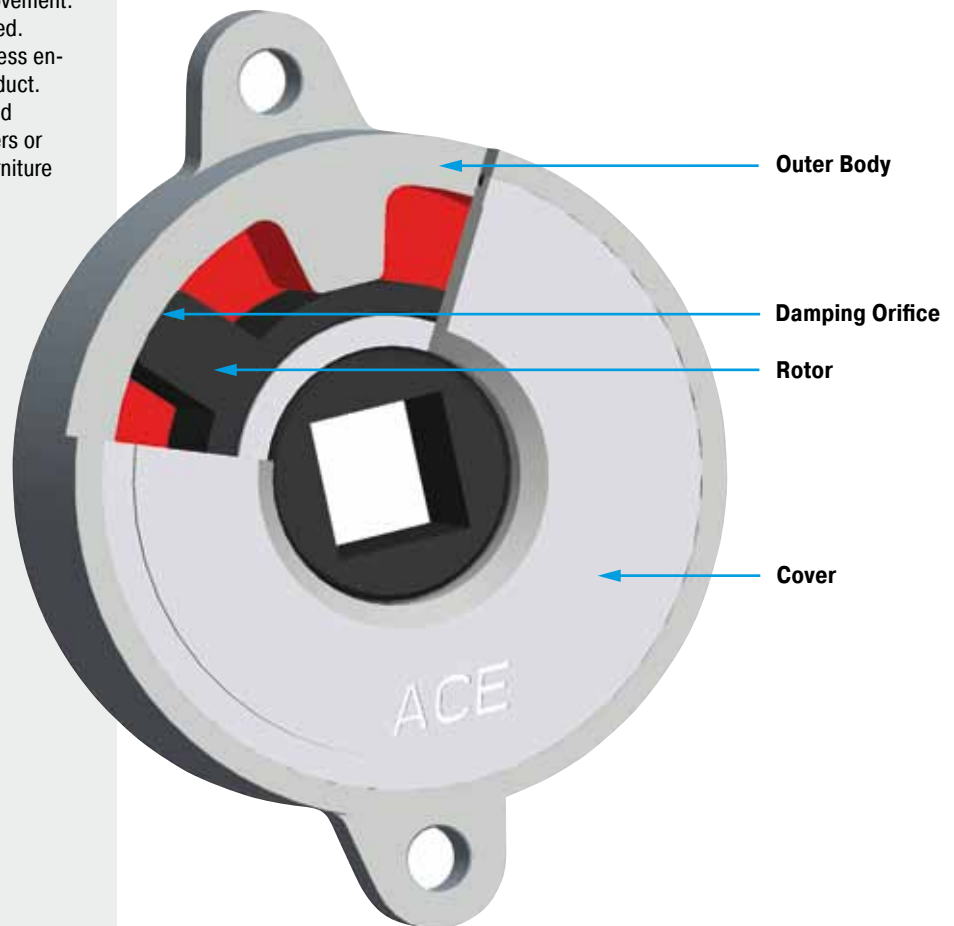

**Function:** In rotary dampers with partial rotation angle, the fluid is forced from one chamber into the other by the movement of a rotor. The damping moment is determined by the viscosity of the fluid and the dimensioning of the throttle gap or throttle orifices. During the relevant return movement, a certain reduced reverse rotation damping moment is created, depending on the size. The damping moments specified in the catalogue always refer to the maximum moment calculated from the application to which the dampers can be stressed.

**Note:** In general, ACE rotary dampers are tested for a service life of 50 000 cycles. Even after this time, the dampers still produce over approx. 80% of their original damping moment. The service life may be significantly higher or lower, depending on the application. Much higher service lives have however been achieved in practice.



### FYN-P1

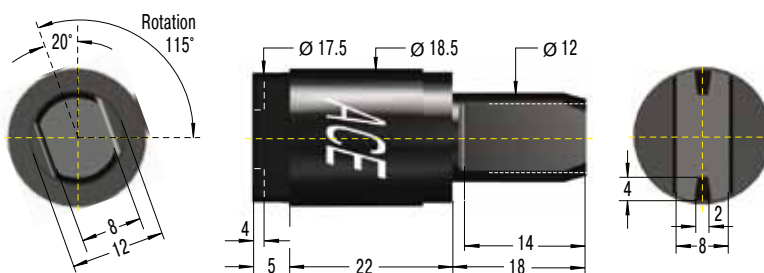

#### Technical Data

**Weight:** 0.010 kg  
**Material:** Polycarbonate plastic  
**Max. rotation angle:** 115 °  
**Operating temperature range:** -5 °C to 50 °C

*"Coloured shaft for identification of the damping direction!"*



Do not use damper as final end stop. Fit external mechanical stops at each end of travel.

Right-Hand Damping (clockwise)	Left-Hand Damping (anti-clockwise)	Damping Torque Ncm	Return Damping Torque Ncm
FYN-P1-R103	FYN-P1-L103	100	30
FYN-P1-R153	FYN-P1-L153	150	50
FYN-P1-R183	FYN-P1-L183	180	80

### FYN-N1

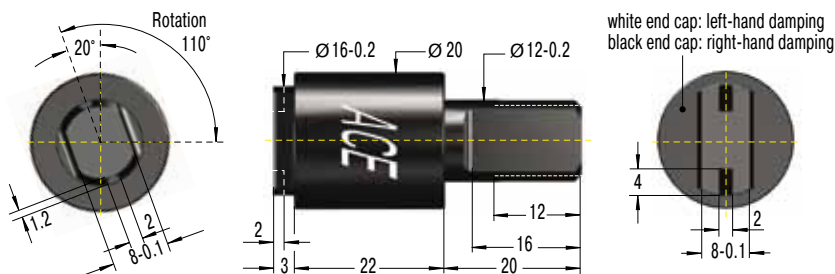
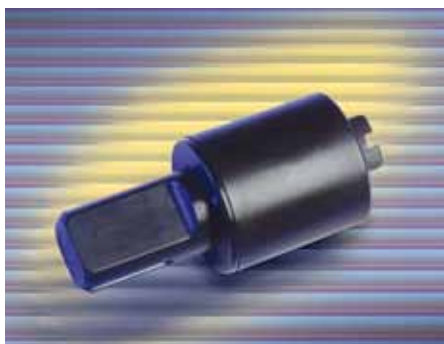

#### Technical Data

**Weight:** 0.012 kg  
**Material:** Polycarbonate plastic  
**Max. rotation angle:** 110 °  
**Operating temperature range:** -5 °C to 50 °C

*"Coloured end cap for identification of the damping direction!"*



Do not use damper as final end stop. Fit external mechanical stops at each end of travel.

Right-Hand Damping (clockwise)	Left-Hand Damping (anti-clockwise)	Damping Torque Ncm	Return Damping Torque Ncm
FYN-N1-R103	FYN-N1-L103	100	20
FYN-N1-R203	FYN-N1-L203	200	40
FYN-N1-R253	FYN-N1-L253	250	40
FYN-N1-R303	FYN-N1-L303	300	80

#### FYN-U1

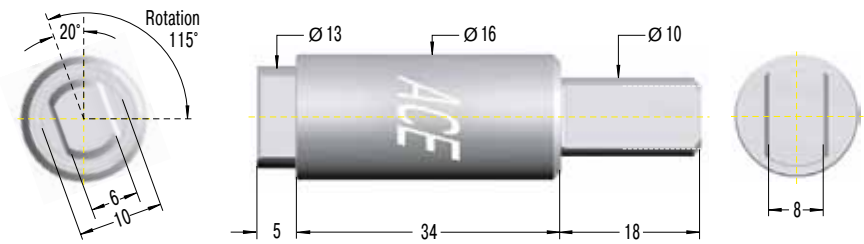

#### Technical Data

**Weight:** 0.04 kg  
**Material:** Zinc die-cast  
**Max. rotation angle:** 115 °  
**Operating temperature range:** -5 °C to 50 °C

Do not use damper as final end stop. Fit external mechanical stops at each end of travel.

Right-Hand Damping (clockwise)	Left-Hand Damping (anti-clockwise)	Damping Torque <b>Ncm</b>	Return Damping Torque <b>Ncm</b>
FYN-U1-R203	FYN-U1-L203	200	40
FYN-U1-R253	FYN-U1-L253	250	40
FYN-U1-R303	FYN-U1-L303	300	80

#### FYN-S1

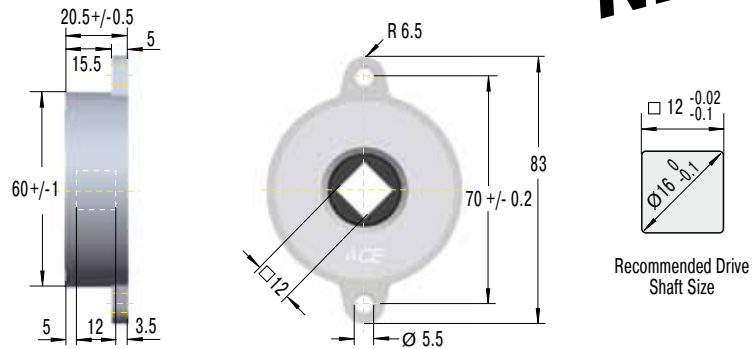
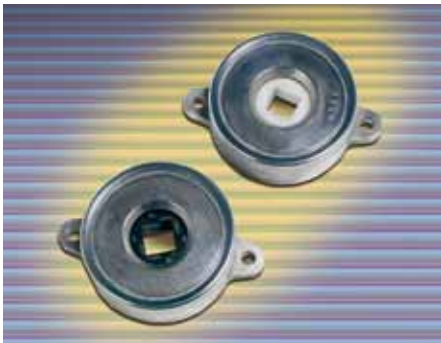

**NEW**

#### Technical Data

**Weight:** 0.22 kg  
**Material:** Zinc die-cast.  
 Output shaft sleeve: Plastic  
**Max. rotation angle:** 130 °  
**Return damping torque:** 1.5 Nm  
**Operating temperature range:** -5 °C to 50 °C

*"Self-Compensating – constant motion with different masses!"*



Do not use damper as final end stop. Fit external mechanical stops at each end of travel.

Right-Hand Damping (clockwise)	Self-Compensating Damping Torque <b>Nm</b>	Left-Hand Damping (anti-clockwise)	Self-Compensating Damping Torque <b>Nm</b>
FYN-S1-R104	5 - 10	FYN-S1-L104	5 - 10



**ACE rotary dampers** are maintenance-free and ready to install. The damping direction of the adjustable rotary dampers with partial rotation angle can be clockwise, counter clockwise or both. The outer bodies are of die-cast zinc, and the shafts of steel. The dampers ensure the controlled opening and closing of hoods, covers or flaps. They can damp directly at the rotation point or by transmission via a pinion, in order to produce a smooth and even movement. Sensitive components remain unstressed. The harmonious gentle movement process enhances the quality and value of the product. Particularly suitable for flaps, covers, closing hoods for such items as printers and photocopiers, the furniture industry etc.

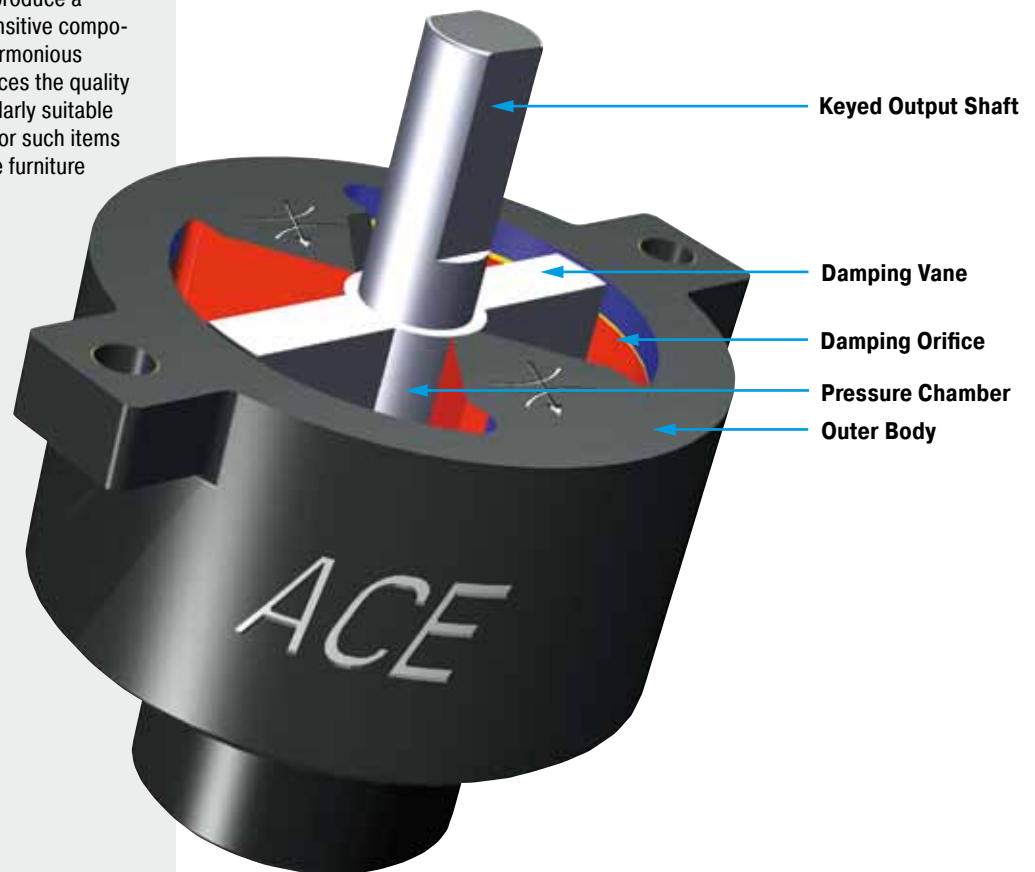

**Function:** In adjustable rotary dampers with partial rotation angle, the fluid is forced from one chamber into the other by adjustable orifices. The damping moment is determined by the viscosity of the fluid and the dimensioning of the orifice sizes. During the return movement of unidirectional dampers a small reverse damping moment is created, depending on the size. The damping moments specified in the catalogue always refer to the maximum moment calculated from the application to which the dampers can be stressed.

**Note:** In general, ACE rotary dampers are tested for a service life of 50 000 cycles. Even after this time, the dampers still produce over approx. 80% of their original damping moment. The service life may be significantly higher or lower, depending on the application. Much higher service lives have however been achieved in practice.



#### FYT-H1 and FYN-H1

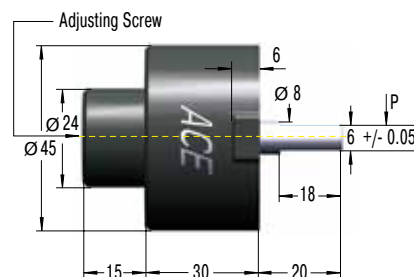
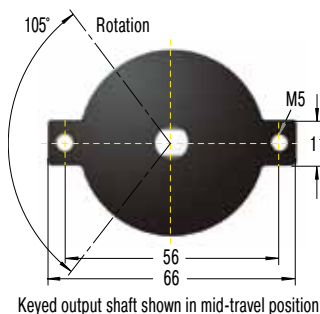

#### Technical Data

**Weight:** 0.24 kg  
**Material:** Zinc die-cast, steel shaft  
**Max. rotation angle:** 105 °  
**Maximum side load:** 50 N  
**Return damping torque:** 0.5 Nm  
**Operating temperature range:** -5 °C to 50 °C

A play of approx. 5° can occur at the beginning of movement.

Do not use damper as final end stop. Fit external mechanical stops at each end of travel.

#### Model Adjustable

	Adjustable
<b>Bidirectional Damping</b>	Damping Torque <b>Nm</b>
FYT-H1	2 - 10

#### Model Adjustable

	Adjustable
<b>Right-Hand Damping</b> (clockwise)	Damping Torque <b>Nm</b>
FYN-H1-R	2 - 10

#### Model Adjustable

	Adjustable
<b>Left-Hand Damping</b> (anti-clockwise)	Damping Torque <b>Nm</b>
FYN-H1-L	2 - 10

#### FYT-LA3 and FYN-LA3

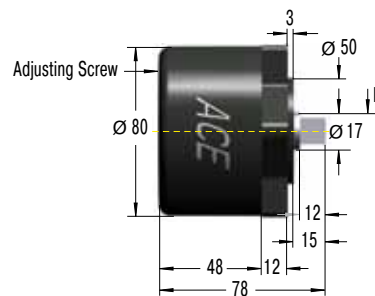
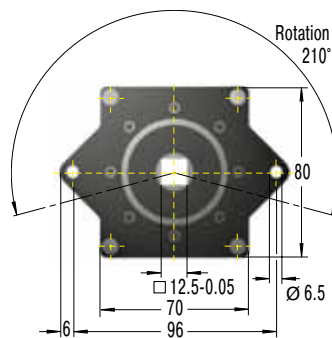
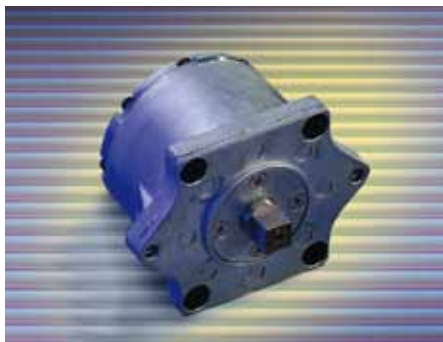

#### Technical Data

**Weight:** 1.75 kg  
**Material:** Zinc die-cast, steel shaft  
**Max. rotation angle:** 210 °  
**Maximum side load:** 200 N  
**Return damping torque:** 4 Nm  
**Operating temperature range:** -5 °C to 50 °C

A play of approx. 5° can occur at the beginning of movement.

Do not use damper as final end stop. Fit external mechanical stops at each end of travel.

#### Model Adjustable

	Adjustable
<b>Bidirectional Damping</b>	Damping Torque Nm <b>Nm</b>
FYT-LA3	4 - 40

#### Model Adjustable

	Adjustable
<b>Right-Hand Damping</b> (clockwise)	Damping Torque <b>Nm</b>
FYN-LA3-R	4 - 40

#### Model Adjustable

	Adjustable
<b>Left-Hand Damping</b> (anti-clockwise)	Damping Torque <b>Nm</b>
FYN-LA3-L	4 - 40

### Calculation of Rotary Damper for a Lid

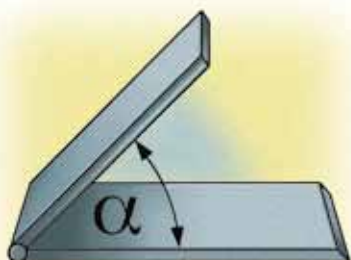

Closing Torque T

$$M = L / 2 \cdot m \cdot \cos \alpha$$

Note: for a uniform lid assume centre of gravity is at distance L / 2 from pivot.

- m** Mass of a lid (kg)
- L** Length of lid from pivot (cm)
- n** Rotation speed (r.p.m.)

#### Calculation Steps

- 1) Calculate max. torque damper will be exposed to (with example shown max. torque is at  $\alpha = 0$ ).
- 2) Decide upon rotation speed desired.
- 3) Choose a rotary damper from catalogue that can handle the torque calculated above.
- 4) With the aid of the damper performance curves, check if the r.p.m. given at your torque corresponds to the desired closing speed of the lid.
- 5) If the r.p.m. is too high – choose a damper with a higher torque rating.  
If the r.p.m. is too low – choose a damper with a lower torque rating.

### Mountings to Avoid

The output shaft should **not** be exposed to side loading.



Side loading



End loading



Angular offset

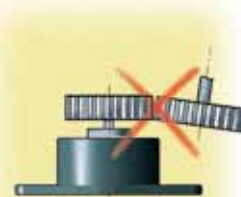

Misalignment

### Toothed Rack M0.5, M0.6, M0.8, M1.0

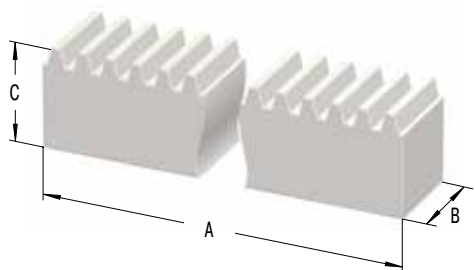

### Toothed Rack M0.8P

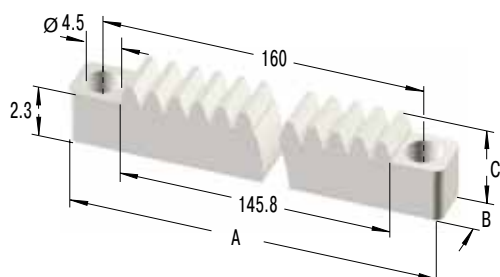

#### Damping Direction

right hand damping = damping action in clockwise direction when looking onto the output shaft

#### Accessories

Toothed plastic rack with modules 0.5 to 1.0 available.

#### Models Available

Type	A	B	C	Model
M0.5	250	4	4.5	rigid, milled
M0.6	250	4	6	rigid, milled
M0.8	250	6	8	rigid, milled
M0.8P	170	8	4.1	flexible, milled
M1.0	250	9	9	rigid, milled
M1.0	500	10	10	rigid, milled

Metal racks available on request.



**Even rhythm**

**ACE rotary dampers** ensure the quiet shuffling of playing cards. Software controlled playing card shuffling machines such as this one are used throughout the world and are equipped with the **FRT-G2-101-G1** type rotary dampers. Maintenance-free and ready to install. Before inserting the set of cards, you can ensure the quiet stopping of the plastic wedge in the equipment when it is driven upwards. The dampers can be applied to suit your requirements; clockwise, anticlockwise or in both directions; and they are just as reliable as the open and close slides in high quality DVD or CD players.



one2six is a trademark and copyright of Shuffle Master, Inc.

Playing cards are shuffled simply and quietly

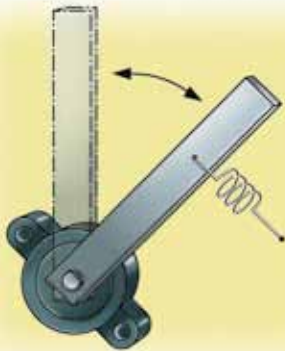

**Damping lever motions**

**ACE rotary dampers** protect the keyboard.

To provide long term protection in arduous and often dirty industrial applications (and also to protect against unauthorised access) the machine keyboard is installed in a lockable and pivoted housing cabinet.

ACE rotary dampers type **FRN-F1** were installed on the pivot axis to provide a smooth controlled motion to the keyboard as it is pulled down into its operating position. The damper also prevents overloading the hinge system and prevents damage to the keyboard, the housing cabinet and the hinges.



Pivoted machine keyboard