

Based on the innovative design concepts of the MAGNUM range, ACE introduces the **SCS33 to SCS64 series of safety shock absorbers**. Designed to provide machine protection in an emergency runaway situation the SCS33 to SCS64 series provide a cost effective method of protecting vital machinery in emergency stop situations. Specially optimised orificing design provides **extremely high capacity** in a compact envelope size making them ideal for critical applications on portal gantry systems, automatic transfer machines and robot systems where an emergency runaway could otherwise result in expensive damage or danger. With up to 300% higher capacity than other shock absorber designs the SCS33 to 64 range provides true linear deceleration protecting vital equipment at an affordable cost. Optional rod sensor available for indicating the complete retraction of the piston rod.

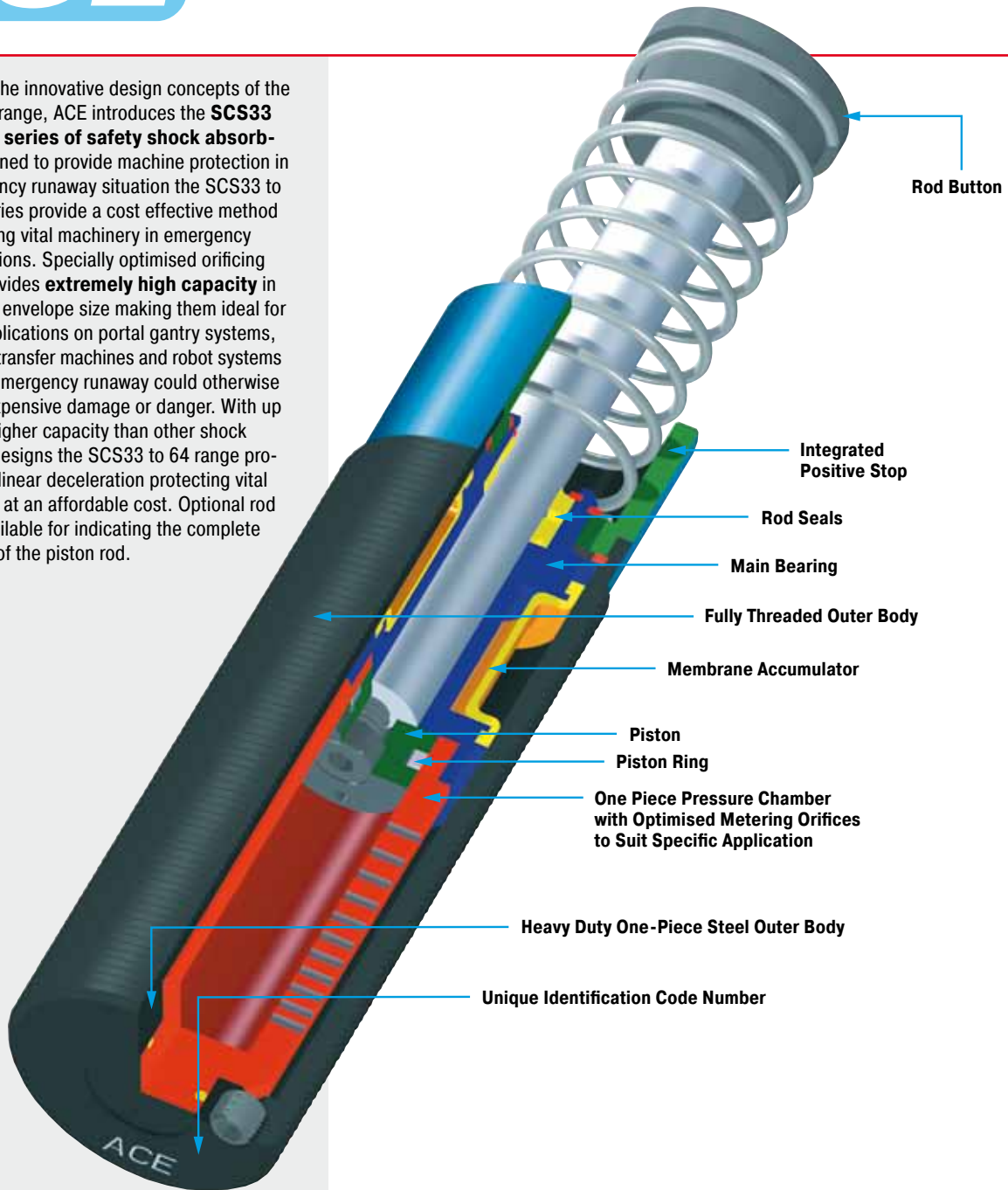

Impact cycles per hour: max. 1

Life expectancy: Self-compensating version: max. 1000 cycles.
Optimised version: max. 5 cycles.

Impact velocity range: On request

Operating fluid: Automatic Transmission Fluid (ATF) at 42cSt.

Material: Shock absorber body: Nitride hardened steel. Accessories: Steel with black oxide finish. Piston rod: Steel hardened and chrome plated. Rod end button: Hardened steel with black oxide finish. Return Spring: Zinc plated or plastic-coated.

Energy capacity W_3 : At max. side load angle do not exceed 80% of rated max. energy capacity below.

Mounting: In any position

Operating temperature range:
-12 °C to 70 °C. Higher temperatures on request.

In creep speed: The shock absorber can be pushed through its stroke. In creep speed conditions the shock absorber provides minimal resistance and there is no braking effect.



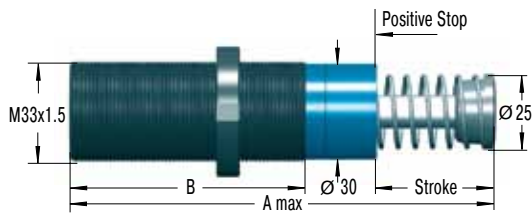

Standard Dimensions

NM33

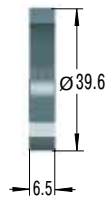

Locking Ring

QF33

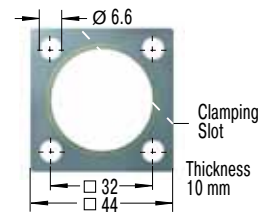

Square Flange

Install with 4 machine screws
Tightening torque: 11 Nm
Clamping torque: > 90 Nm

S33

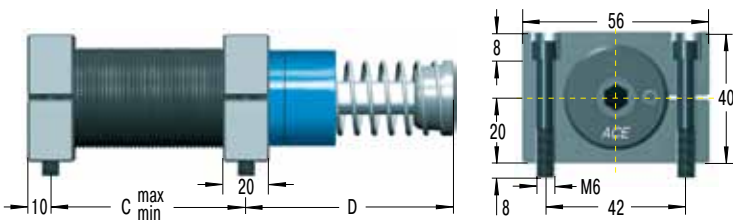

Side Foot Mounting Kit

S33 = 2 flanges + 4 screws M6x40, DIN 912
Because of the thread pitch the fixing holes for the second foot mount should only be drilled and tapped after the first foot mount has been fixed in position.

Tightening torque: 11 Nm (screws)
Clamping torque: > 90 Nm

Ordering Example

Safety Shock Absorber _____
Thread Size M33 _____
Max. Stroke without Positive Stop 50 mm _____
EU Compliant _____
Mounting Style: Foot _____
Identification No. assigned by ACE _____

SCS33-50EU-S-1xxxx

Please indicate identification no. in case of replacement order

Complete Details Required when Ordering

Moving load m (kg)
Impact velocity range v (m/s) max.
Creep speed vs (m/s)
Motor power P (kW)
Stall torque factor ST (normal 2.5)
Number of absorbers in parallel n

or technical data according to formulae and calculations on page 15 to 17.

The calculation and selection of the correct ACE safety shock absorber for your application should be referred to ACE for approval and assignment of unique identification number.

Dimensions and Capacity Chart

Type	Stroke mm	A max	B	C min	C max	D	Max. Energy Capacity		Min. Return Force N	Max. Return Force N	Max. Side Load Angle °	Weight kg
							Self-Compensating W ₃ Nm/Cycle	Optimised Version W ₃ Nm/Cycle				
SCS33-25EU	23	138	83	25	60	68	310	500	45	90	3	0.45
SCS33-50EU	48.5	189	108	32	86	93	620	950	45	135	2	0.54

For other stroke lengths, special options (such as higher or lower impact velocity etc.), please consult ACE.

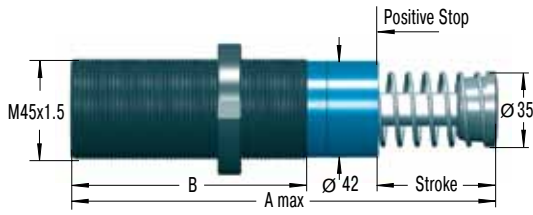

Standard Dimensions

NM45

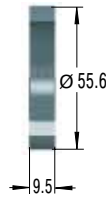

Locking Ring

QF45

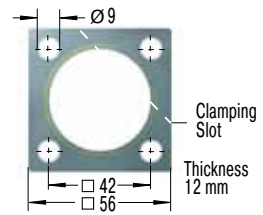

Square Flange

Install with 4 machine screws
Tightening torque: 27 Nm
Clamping torque: > 200 Nm

S45

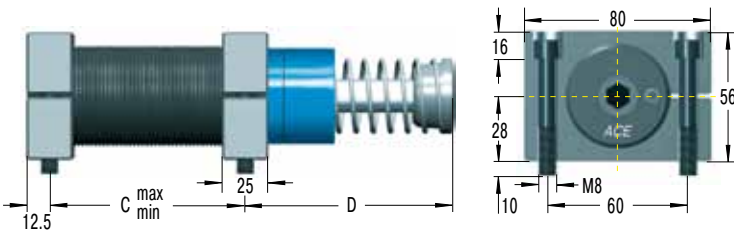

Side Foot Mounting Kit

S45 = 2 flanges + 4 screws M8x50, DIN 912
Because of the thread pitch the fixing holes for the second foot mount should only be drilled and tapped after the first foot mount has been fixed in position.

Tightening torque: 27 Nm (screws)
Clamping torque: > 350 Nm

Ordering Example

Safety Shock Absorber _____
Thread Size M45 _____
Max. Stroke without Positive Stop 50 mm _____
EU Compliant _____
Mounting Style: Foot _____
Identification No. assigned by ACE _____

SCS45-50EU-S-1xxxx

Please indicate identification no. in case of replacement order

Complete Details Required when Ordering

Moving load m (kg)
Impact velocity range v (m/s) max.
Creep speed vs (m/s)
Motor power P (kW)
Stall torque factor ST (normal 2.5)
Number of absorbers in parallel n

or technical data according to formulae and calculations on page 15 to 17.

The calculation and selection of the correct ACE safety shock absorber for your application should be referred to ACE for approval and assignment of unique identification number.

Dimensions and Capacity Chart

Type	Stroke mm	A max	B	C min	C max	D	Max. Energy Capacity		Min. Return Force N	Max. Return Force N	Max. Side Load Angle °	Weight kg
							Self-Compensating W ₃ Nm/Cycle	Optimised Version W ₃ Nm/Cycle				
SCS45-25EU	23	145	95	32	66	66	680	1 200	70	100	3	1.13
SCS45-50EU	48.5	195	120	40	92	91	1 360	2 350	70	145	2	1.36
SCS45-75EU	74	246	145	50	118	116	2 040	3 500	50	180	1	1.59

For other stroke lengths, special options (such as higher or lower impact velocity etc.), please consult ACE.

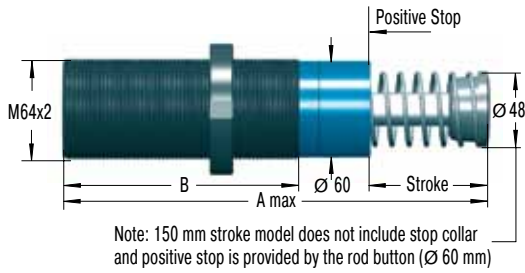

Standard Dimensions

Note: 150 mm stroke model does not include stop collar and positive stop is provided by the rod button (Ø 60 mm)

NM64

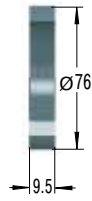

Locking Ring

QF64

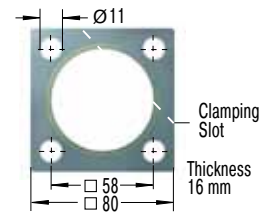

Square Flange

Install with 4 machine screws
Tightening torque: 50 Nm
Clamping torque: > 210 Nm

S64

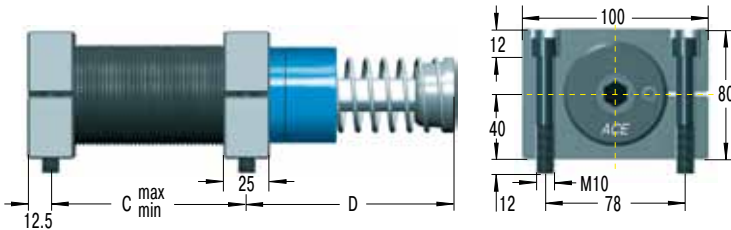

Side Foot Mounting Kit

S64 = 2 flanges + 4 screws M10x80, DIN 912
Because of the thread pitch the fixing holes for the second foot mount should only be drilled and tapped after the first foot mount has been fixed in position.

Tightening torque: 50 Nm (screws)
Clamping torque: > 350 Nm

Ordering Example

Safety Shock Absorber _____
Thread Size M45 _____
Max. Stroke without Positive Stop 50 mm _____
EU Compliant _____
Mounting Style: Foot _____
Identification No. assigned by ACE _____

SCS45-50EU-S-1xxxx

Please indicate identification no. in case of replacement order

Complete Details Required when Ordering

Moving load m (kg)
Impact velocity range v (m/s) max.
Creep speed vs (m/s)
Motor power P (kW)
Stall torque factor ST (normal 2.5)
Number of absorbers in parallel n

or technical data according to formulae and calculations on page 15 to 17.

The calculation and selection of the correct ACE safety shock absorber for your application should be referred to ACE for approval and assignment of unique identification number.

Dimensions and Capacity Chart

Type	Stroke mm	A max	B	C min	C max	D	Max. Energy Capacity		Min. Return Force N	Max. Return Force N	Max. Side Load Angle °	Weight kg
							Self-Compensating W ₃ Nm/Cycle	Optimised Version W ₃ Nm/Cycle				
SCS64-50EU	48.5	225	140	50	112	100	3 400	6 000	90	155	3	3.18
SCS64-100EU	99.5	326	191	64	162	152	6 800	12 000	105	270	2	4.2
SCS64-150EU	150	450	241	80	212	226	10 200	18 000	75	365	1	5.65

For other stroke lengths, special options (such as higher or lower impact velocity etc.), please consult ACE.

ACE safety shock absorbers are self-contained and maintenance-free. They are designed for emergency deceleration and are an economic alternative to industrial shock absorbers. The **SCS series** units are available with operating strokes up to 1200 mm and are specially orificed to provide a smooth constant deceleration throughout their entire stroke length. The internal hydraulic pressure and thus the braking force, is maintained at a constant safe level to bring the fast moving load gently to rest in an emergency. Applications specially include conveyor systems, automated storage, cranes and heavy machines. Optional rod sensor available for indicating the complete extension of the piston rod.

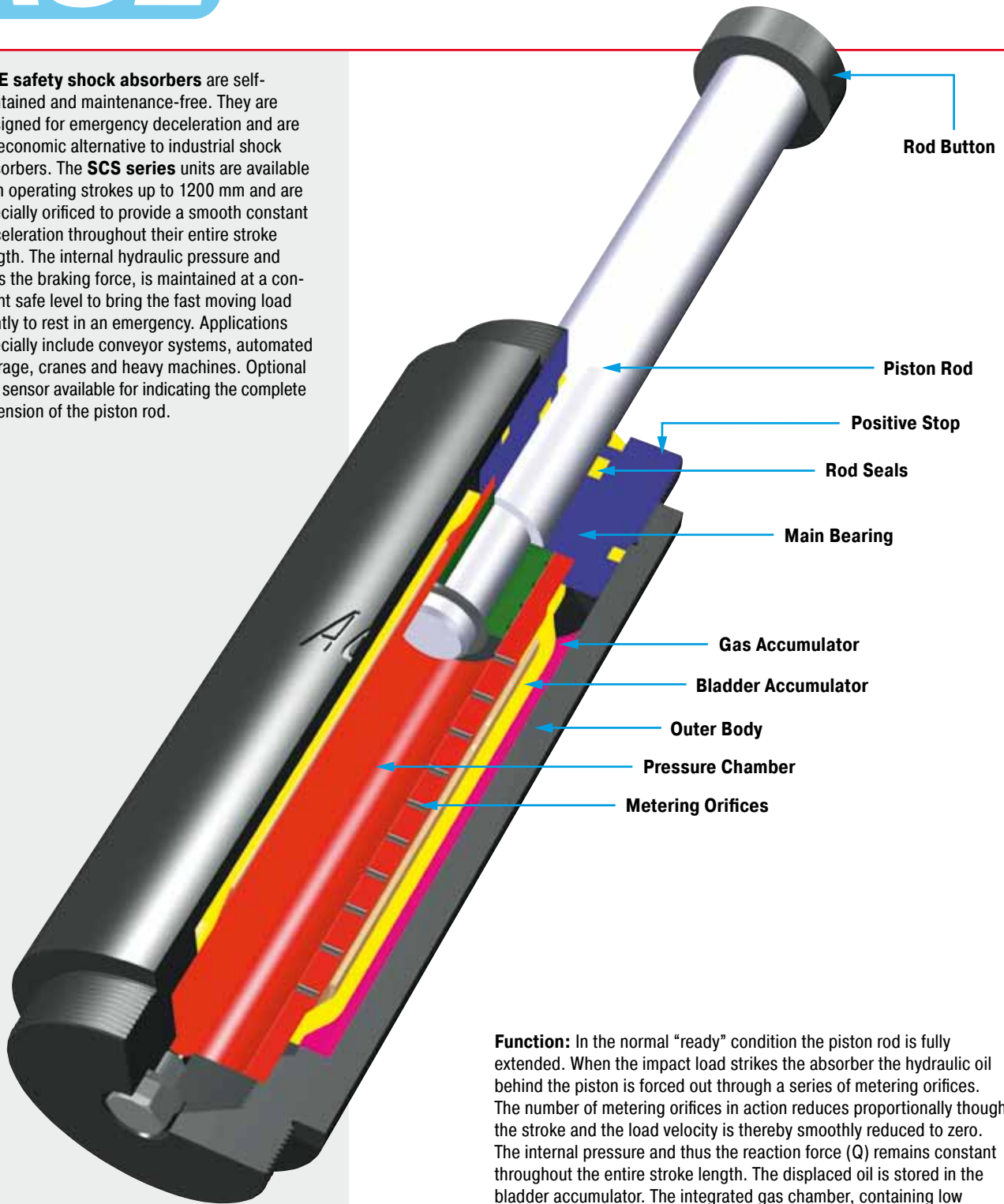

Function: In the normal "ready" condition the piston rod is fully extended. When the impact load strikes the absorber the hydraulic oil behind the piston is forced out through a series of metering orifices. The number of metering orifices in action reduces proportionally though the stroke and the load velocity is thereby smoothly reduced to zero. The internal pressure and thus the reaction force (Q) remains constant throughout the entire stroke length. The displaced oil is stored in the bladder accumulator. The integrated gas chamber, containing low pressure nitrogen, provides the return force to reset the rod to its extended position and functions as an accumulator for the hydraulic oil displaced during the operation.

Material: Steel body with black oxide finish. Piston rod hard chrome plated.

Energy capacity W_3 : At max. side load angle do not exceed 80% of rated max. energy capacity below.

Filling pressure: Approx. 2 bar

Operating temperature range: -12 °C to 66 °C

In creep speed: It is possible to use up to approx. 60% of the buffer stroke. In creep speed conditions the shock absorber provides minimal resistance and there is no braking effect.



Rear Flange -R

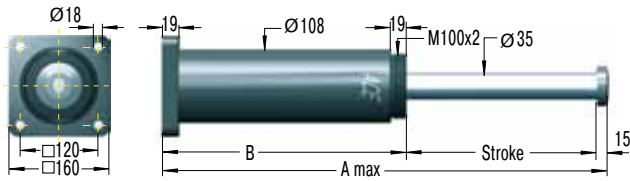

Front Flange -F

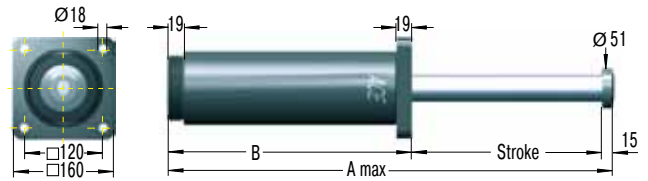

Foot Mounting -S

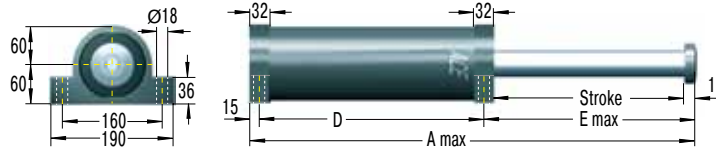

Ordering Example

Safety Shock Absorber _____
 Bore Size Ø 38 mm _____
 Stroke 400 mm _____
 EU Compliant _____
 Mounting Style: Front Flange _____
 Identification No. assigned by ACE _____

SCS38-400EU-F-X

Please indicate identification no. in case of replacement order

Complete Details Required when Ordering

Moving load m (kg)
 Impact velocity range v (m/s) max.
 Creep speed vs (m/s)
 Motor power P (kW)
 Stall torque factor ST (normal 2.5)
 Number of absorbers in parallel n

or technical data according to formulae and calculations on page 15 to 17.

The calculation and selection of the correct ACE safety shock absorber for your application should be referred to ACE for approval and assignment of unique identification number.

Technical Data

Impact velocity range: 0.9 to 4.6 m/s

Reacting force Q: At max. capacity rating = **80 kN max.**

Dimensions and Capacity Chart

Type	Stroke mm	A max	B	D	E max	Max. Energy Capacity W ₃ Nm/Cycle	Mounting Style							
							Min. Return Force N		Max. Return Force N		F & S		R	
							Min. Force N	Max. Force N	Max. Side Load Angle °	Max. Side Load Angle °	F & R Weight kg	S Weight kg		
SCS38-50EU	50	270	205	175	80	3 600	600	700	5	4	12	13		
SCS38-100EU	100	370	255	225	132	7 200	600	700	5	4	14	15		
SCS38-150EU	150	470	305	275	180	10 800	600	700	5	4	16	17		
SCS38-200EU	200	570	355	325	230	14 400	600	700	5	4	18	19		
SCS38-250EU	250	670	405	375	280	18 000	600	700	4.7	3.7	20	21		
SCS38-300EU	300	785	470	440	330	21 600	600	700	3.9	2.9	22	23		
SCS38-350EU	350	885	520	490	380	25 200	600	700	3.4	2.4	24	25		
SCS38-400EU	400	1 000	585	555	430	28 800	600	700	3	2	26	27		
SCS38-500EU	500	1 215	700	670	530	36 000	600	700	2.4	1.4	30	31		
SCS38-600EU	600	1 430	815	785	630	43 200	600	700	1.9	0.9	34	35		
SCS38-700EU	700	1 645	930	900	730	50 400	600	700	1.6	0.6	38	39		
SCS38-800EU	800	1 860	1 045	1 015	830	57 600	600	700	1.3	0.3	43	44		

For other stroke lengths, special options (such as higher or lower impact velocity etc.), please consult ACE.

Rear Flange -R

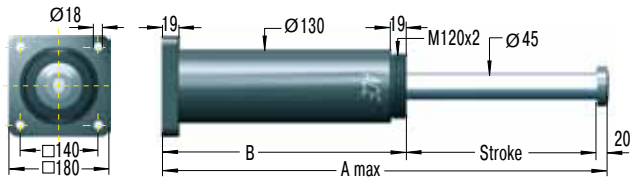

Front Flange -F

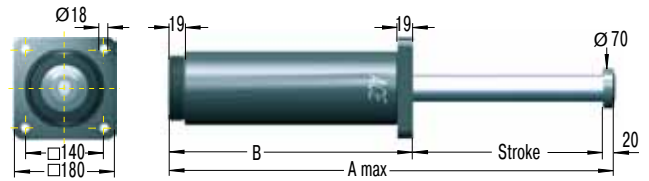

Foot Mounting -S

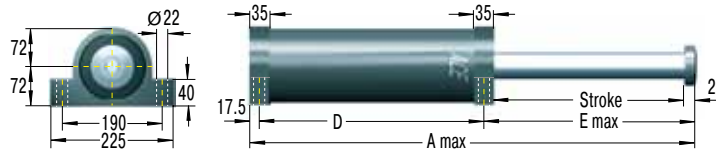

Ordering Example

Safety Shock Absorber _____
 Bore Size Ø 50 mm _____
 Stroke 400 mm _____
 EU Compliant _____
 Mounting Style: Front Flange _____
 Identification No. assigned by ACE _____

SCS50-400EU-F-X

Please indicate identification no. in case of replacement order

Complete Details Required when Ordering

Moving load m (kg)
 Impact velocity range v (m/s) max.
 Creep speed vs (m/s)
 Motor power P (kW)
 Stall torque factor ST (normal 2.5)
 Number of absorbers in parallel n

or technical data according to formulae and calculations on page 15 to 17.

The calculation and selection of the correct ACE safety shock absorber for your application should be referred to ACE for approval and assignment of unique identification number.

Technical Data

Impact velocity range: 0.6 to 4.6 m/s

Reacting force Q: At max. capacity rating = **160 kN max.**

Dimensions and Capacity Chart

Type	Stroke mm	A max	B	D	E max	Max. Energy Capacity W ₃ Nm/Cycle	Mounting Style							
							Min. Return Force N		Max. Return Force N		Mounting Style F & S		Mounting Style R	
							Min. Force N	Max. Force N	Max. Side Load Angle °	Max. Side Load Angle °	F & R Weight kg	S Weight kg		
SCS50-100EU	100	390	270	235	138	14 000	1 000	1 200	5	4	22	23		
SCS50-150EU	150	490	320	285	188	21 000	1 000	1 200	5	4	25	26		
SCS50-200EU	200	590	370	335	238	28 000	1 000	1 200	5	4	27	28		
SCS50-250EU	250	690	420	385	288	35 000	1 000	1 200	4.5	3.5	30	31		
SCS50-300EU	300	805	485	450	338	42 000	1 000	1 200	3.8	2.8	33	34		
SCS50-350EU	350	905	535	500	388	49 000	1 000	1 200	3.3	2.3	35	37		
SCS50-400EU	400	1 020	600	565	438	56 000	1 000	1 200	2.9	1.9	38	40		
SCS50-500EU	500	1 235	715	680	538	70 000	1 000	1 200	2.3	1.3	44	45		
SCS50-600EU	600	1 450	830	795	638	84 000	1 000	1 200	1.9	0.9	50	51		
SCS50-700EU	700	1 665	945	910	738	98 000	1 000	1 200	1.6	0.6	55	57		
SCS50-800EU	800	1 880	1 060	1 025	838	112 000	1 000	1 200	1.3	0.3	61	63		
SCS50-1000EU	1 000	2 310	1 290	1 255	1 038	140 000	1 000	1 200	1	0	72	74		

For other stroke lengths, special options (such as higher or lower impact velocity etc.), please consult ACE.

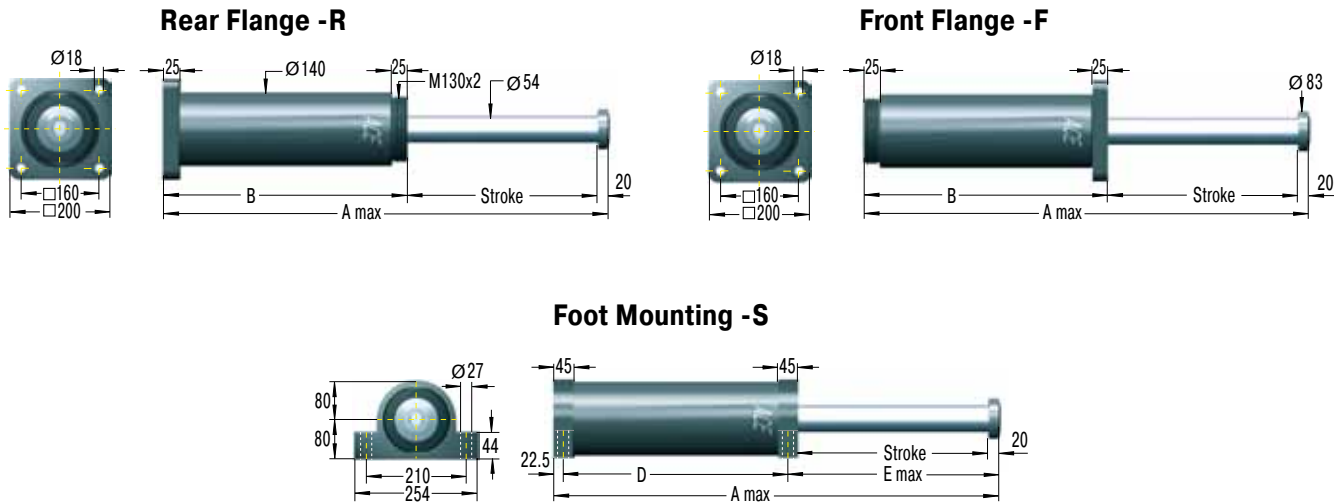

Ordering Example

Safety Shock Absorber _____
 Bore Size Ø 63 mm _____
 Stroke 400 mm _____
 EU Compliant _____
 Mounting Style: Front Flange _____
 Identification No. assigned by ACE _____

SCS63-400EU-F-X

Please indicate identification no. in case of replacement order

Complete Details Required when Ordering

Moving load _____ m (kg)
 Impact velocity range _____ v (m/s) max.
 Creep speed _____ vs (m/s)
 Motor power _____ P (kW)
 Stall torque factor _____ ST (normal 2.5)
 Number of absorbers in parallel _____ n

or technical data according to formulae and calculations on page 15 to 17.

The calculation and selection of the correct ACE safety shock absorber for your application should be referred to ACE for approval and assignment of unique identification number.

Technical Data

Impact velocity range: 0.5 to 4.6 m/s

Reacting force Q: At max. capacity rating = **210 kN max.**

Dimensions and Capacity Chart

Type	Stroke mm	A max	B	D	E max	Max. Energy Capacity W ₃ Nm/Cycle	Mounting Style							
							Min. Return Force N		Max. Return Force N		Mounting Style F & S		Mounting Style R	
							Min. Force N	Max. Force N	Max. Side Load Angle °	Max. Side Load Angle °	F & R Weight kg	S Weight kg		
SCS63-100EU	100	405	285	240	143	18 000	1 500	2 500	5	4	29	32		
SCS63-150EU	150	505	335	290	193	27 000	1 500	2 500	5	4	32	35		
SCS63-200EU	200	605	385	340	243	36 000	1 500	2 500	5	4	36.2	38		
SCS63-250EU	250	705	435	390	293	45 000	1 500	2 500	5	4	38	42		
SCS63-300EU	300	805	485	440	343	54 000	1 500	2 500	5	4	41	45		
SCS63-350EU	350	925	555	510	393	63 000	1 500	2 500	5	4	45	49		
SCS63-400EU	400	1 025	605	560	443	72 000	1 500	2 500	5	4	48	52		
SCS63-500EU	500	1 245	725	680	543	90 000	1 500	2 500	4.2	3.2	55	60		
SCS63-600EU	600	1 445	825	780	643	108 000	1 500	2 500	3.4	2.4	62	66		
SCS63-700EU	700	1 665	945	900	746	126 000	1 500	2 500	2.9	1.9	69	73		
SCS63-800EU	800	1 865	1 045	1 000	843	144 000	1 500	2 500	2.5	1.5	75	79		
SCS63-1000EU	1 000	2 285	1 265	1 220	1 043	180 000	1 500	2 500	1.9	0.9	89	93		
SCS63-1200EU	1 200	2 705	1 485	1 440	1 243	216 000	1 500	2 500	1.4	0.4	102	106		

For other stroke lengths, special options (such as higher or lower impact velocity etc.), please consult ACE.

ACE safety shock absorbers are self-contained and maintenance-free. They are designed for emergency deceleration and are an economic alternative to industrial shock absorbers. The primary oil seals are protected inside the main body and only a wiper seal is necessary on the piston rod. Dirt or contamination on the piston rod does not cause oil leakage or failure as is often the case with conventional buffers. The integrated gas accumulator enables the **CB Series** safety shock absorbers to provide return forces of up to 71 kN. This high return force is necessary for multiple-bridge cranes where the buffers must separate the bridges after an emergency collision. Normal buffers would remain compressed after such a collision and would not be capable of accepting further impacts. The robust, large dimensioned piston rod bearing system, is designed for very heavy duty use and is equivalent to that used in other buffers 80 % larger in size. The CB series units are custom orificed to suit your specific application and provide a smooth constant deceleration throughout their complete stroke length.

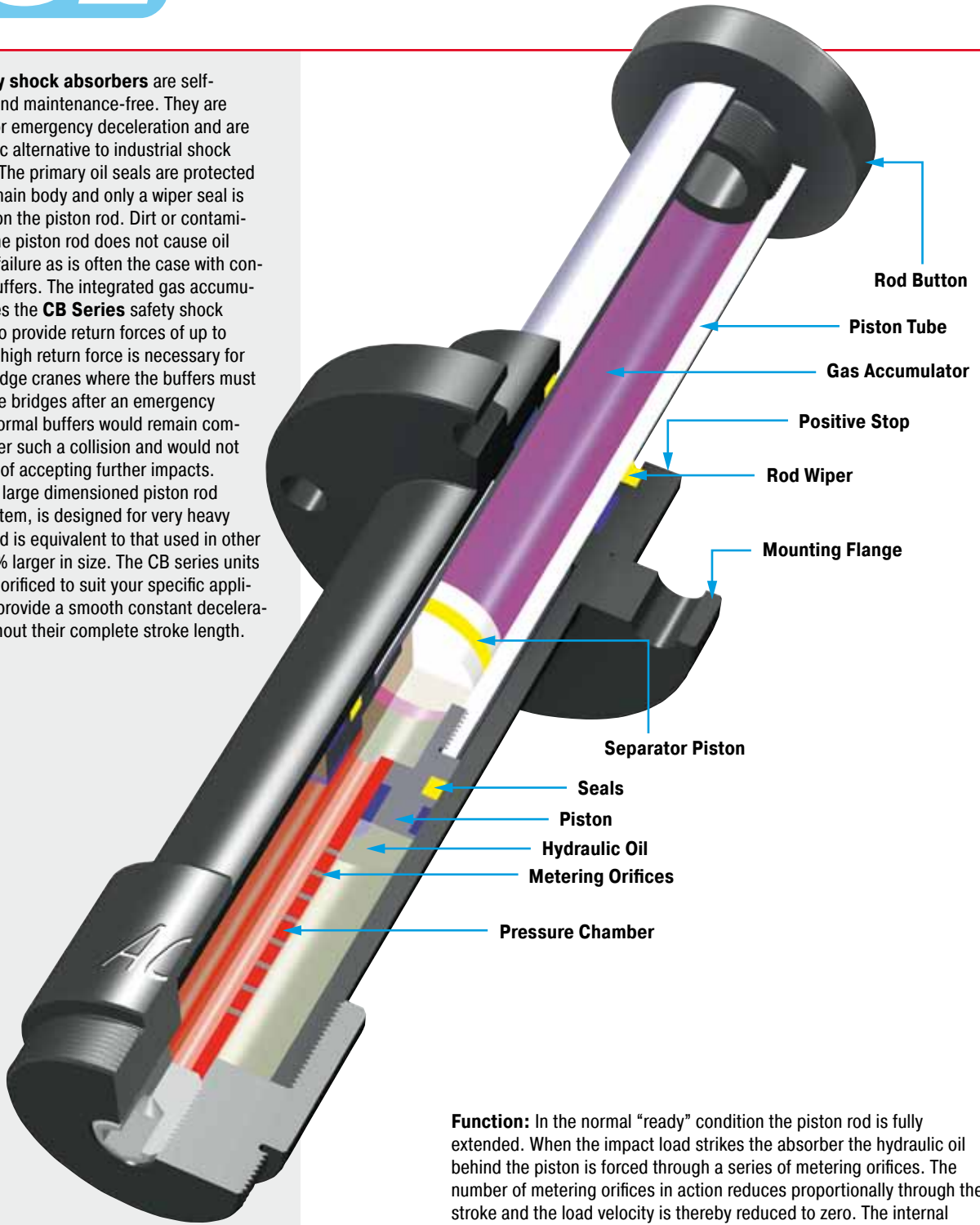

Function: In the normal “ready” condition the piston rod is fully extended. When the impact load strikes the absorber the hydraulic oil behind the piston is forced through a series of metering orifices. The number of metering orifices in action reduces proportionally through the stroke and the load velocity is thereby reduced to zero. The internal pressure and thus the reaction force (Q) remains constant throughout the entire stroke length. The displaced oil is directed inside the piston rod where a separator piston keeps the oil and the nitrogen gas apart. The integrated gas accumulator, containing low pressure nitrogen, provides the high return force to reset the rod to its extended position and generates the high return forces to comply with crane installations.

Impact velocity range:
0.5 to 4.6 m/s

Material: Steel body with black oxide finish. Piston rod hard chrome plated.

Operating temperature range:
-12 °C to 66 °C

Initial fill pressure: governs the rod return force.

In creep speed: The shock absorber can be pushed through its stroke.



Front Flange -F

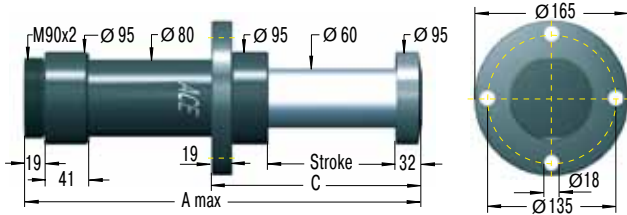

Rear Flange -R

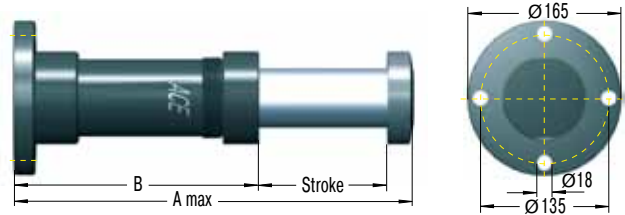

Ordering Example

Safety Shock Absorber _____
 Bore Size Ø 63 mm _____
 Stroke 400 mm _____
 EU Compliant _____
 Mounting Style: Front Flange _____
 Identification No. assigned by ACE _____

CB63-400EU-F-X

Please indicate identification no. in case of replacement order

Complete Details Required when Ordering

Moving load m (kg)
 Impact velocity range v (m/s)max.
 Creep speed vs (m/s)
 Motor power P (kW)
 Stall torque factor ST (normal 2.5)
 Number of absorbers in parallel n

or technical data according to formulae and calculations on page 15 to 17.

The calculation and selection of the correct ACE safety shock absorber for your application should be referred to ACE for approval and assignment of unique identification number.

Technical Data

Reacting force Q: At max. capacity rating = **187 kN max.**

Rod return: Nitrogen accumulator (5.6 bar to 5.9 bar)

Dimensions and Capacity Chart

Type	Stroke mm	A max	B	C	Max. Energy Capacity W ₃ Nm/Cycle	1 Effective Weight me		Min. Return Force N	Max. Return Force N	Max. Side Load Angle °	Weight kg
						me min. kg	me max. kg				
CB63-100EU	100	420	288	192	16 000	900	128 000	1 700	18 500	3.5	12.7
CB63-200EU	200	700	468	292	32 000	1 800	256 000	1 700	24 000	3	16.7
CB63-300EU	300	980	648	392	48 000	2 700	384 000	1 700	27 000	2.5	20.8
CB63-400EU	400	1 260	828	492	64 000	3 700	512 000	1 700	29 000	2	24.8
CB63-500EU	500	1 540	1 008	592	80 000	4 700	640 000	1 700	30 000	1.5	28.8

¹ The correct effective weight range for your application will be calculated by ACE and should fall within this band.

Special options: Special oils, special flanges, additional corrosion protection etc. available on request.

Front Flange -F

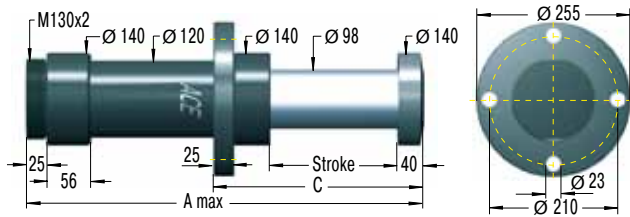

Rear Flange -R

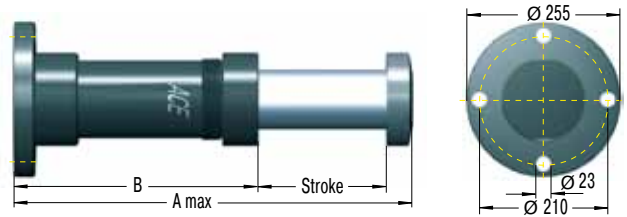

Ordering Example

Safety Shock Absorber _____ **CB100-400EU-F-X**
 Bore Size Ø 100 mm _____
 Stroke 400 mm _____
 EU Compliant _____
 Mounting Style: Front Flange _____
 Identification No. assigned by ACE _____

Please indicate identification no. in case of replacement order

Complete Details Required when Ordering

Moving load _____ m (kg)
 Impact velocity range _____ v (m/s)max.
 Creep speed _____ vs (m/s)
 Motor power _____ P (kW)
 Stall torque factor _____ ST (normal 2.5)
 Number of absorbers in parallel _____ n

or technical data according to formulae and calculations on page 15 to 17.

The calculation and selection of the correct ACE safety shock absorber for your application should be referred to ACE for approval and assignment of unique identification number.

Technical Data

Reacting force Q: At max. capacity rating = **467 kN max.**

Rod return: Nitrogen accumulator (5.6 bar to 5.9 bar)

Dimensions and Capacity Chart

Type	Stroke mm	A max	B	C	Max. Energy Capacity W ₃ Nm/Cycle	1 Effective Weight me		Min. Return Force N	Max. Return Force N	Max. Side Load Angle °	Weight kg
						me min. kg	me max. kg				
CB100-200EU	200	735	495	320	80 000	6 900	640 000	4 500	44 000	4	58.6
CB100-300EU	300	1 005	665	420	120 000	10 300	960 000	4 500	56 000	3.5	70
CB100-400EU	400	1 275	835	520	160 000	13 800	1 280 000	4 500	65 000	3	82.5
CB100-500EU	500	1 545	1 005	620	200 000	17 200	1 600 000	4 500	71 000	2.5	67.5
CB100-600EU	600	1 815	1 175	720	240 000	20 700	1 920 000	4 500	76 000	2	75.8

¹ The correct effective weight range for your application will be calculated by ACE and should fall within this band.

Special options: Special oils, special flanges, additional corrosion protection etc. available on request.

Front Flange -F

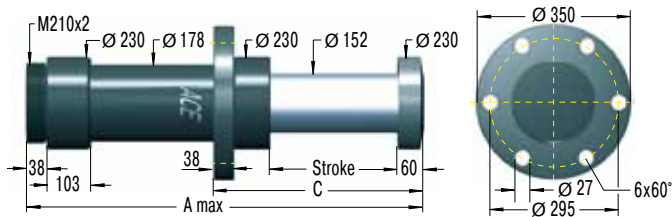

Rear Flange -R

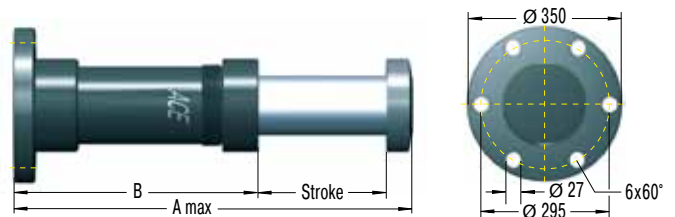

Ordering Example

Safety Shock Absorber _____
 Bore Size Ø 160 mm _____
 Stroke 400 mm _____
 EU Compliant _____
 Mounting Style: Front Flange _____
 Identification No. assigned by ACE _____

CB160-400EU-F-X

Please indicate identification no. in case of replacement order

Complete Details Required when Ordering

Moving load m (kg)
 Impact velocity range v (m/s)max.
 Creep speed vs (m/s)
 Motor power P (kW)
 Stall torque factor ST (normal 2.5)
 Number of absorbers in parallel n

or technical data according to formulae and calculations on page 15 to 17.

The calculation and selection of the correct ACE safety shock absorber for your application should be referred to ACE for approval and assignment of unique identification number.

Technical Data

Reacting force Q: At max. capacity rating = **700 kN max.**

Rod return: Nitrogen accumulator (5.6 bar to 5.9 bar)

Dimensions and Capacity Chart

Type	Stroke mm	A max	B	C	Max. Energy Capacity W_3 Nm/Cycle	1 Effective Weight me		Min. Return Force N	Max. Return Force N	Max. Side Load Angle °	Weight kg
						me min. kg	me max. kg				
CB160-400EU	400	1 400	940	600	240 000	22 700	1 920 000	11 000	71 000	4	154.6
CB160-600EU	600	2 000	1 340	800	360 000	34 000	2 880 000	11 000	71 000	3	188
CB160-800EU	800	2 600	1 740	1 000	480 000	45 400	3 840 000	11 000	71 000	2	221.3

¹ The correct effective weight range for your application will be calculated by ACE and should fall within this band.

Special options: Special oils, special flanges, additional corrosion protection etc. available on request.

The newly-developed EB series offers all the advantages of the CB series such as internal system seals, generously dimensioned piston rod bearings and maximum energy absorption for emergency braking. The internal spring assembly in the piston tube ensures reliable extension of the piston rod following compression. Because of the extension via the spring assembly, the extension forces are reduced significantly in comparison to the CB series. The performance curve and damping characteristics of the maintenance-free and ready-to-install EB safety shock absorber, like all ACE safety shock absorbers, is individually tailored to the relevant application.

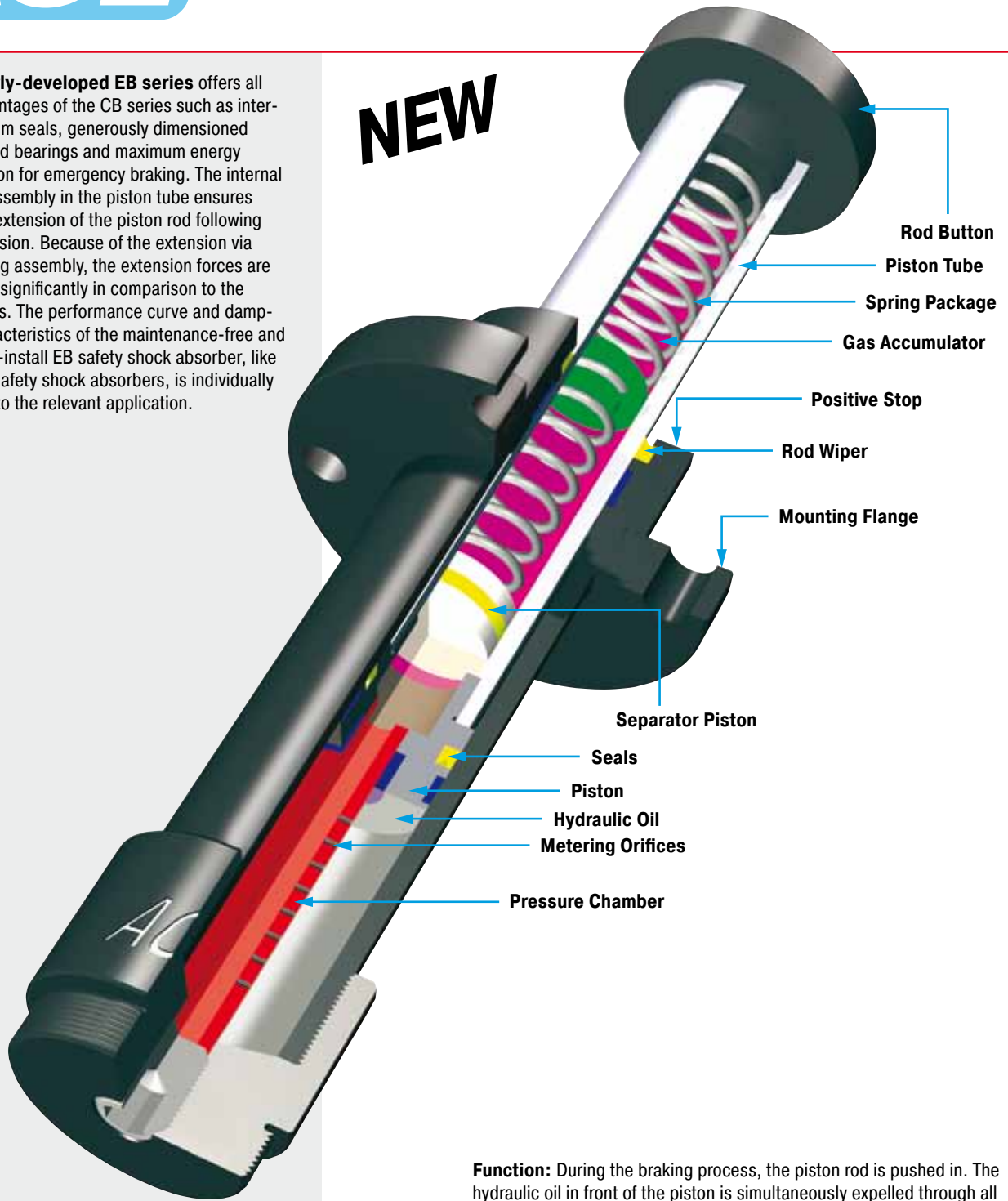

Function: During the braking process, the piston rod is pushed in. The hydraulic oil in front of the piston is simultaneously expelled through all orifice openings. The number of orifice openings in effect reduces in proportion to the stroke movement. The retraction speed is reduced. The back-pressure created in front of the piston, and therefore the counterforce (Q), remain constant during the complete stroke. The oil volume displaced by the piston rod is compensated for by the separating piston. The piston rod is extended again by the spring assembly in the piston tube.

Impact velocity range:
0.5 to 4.6 m/s

Material: Steel body with black oxide finish. Piston rod hard chrome plated.

Operating temperature range:
-12 °C to 66 °C

Initial fill pressure: governs the rod return force.

In creep speed: The shock absorber can be pushed through its stroke.



Front Flange -F

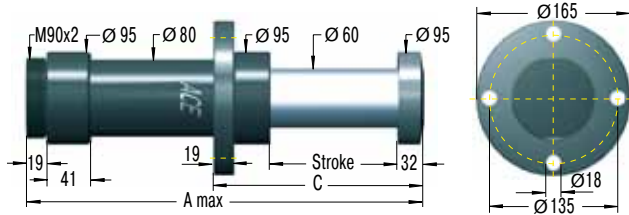

Rear Flange -R

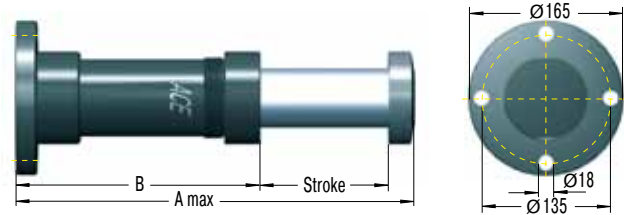

Ordering Example

Safety Shock Absorber _____
 Bore Size Ø 63 mm _____
 Stroke 400 mm _____
 EU Compliant _____
 Mounting Style: Front Flange _____
 Identification No. assigned by ACE _____

EB63-400EU-F-X

Please indicate identification no. in case of replacement order

Complete Details Required when Ordering

Moving load _____ m (kg)
 Impact velocity range _____ v (m/s)max.
 Creep speed _____ vs (m/s)
 Motor power _____ P (kW)
 Stall torque factor _____ ST (normal 2.5)
 Number of absorbers in parallel _____ n

or technical data according to formulae and calculations on page 15 to 17.

The calculation and selection of the correct ACE safety shock absorber for your application should be referred to ACE for approval and assignment of unique identification number.

Technical Data

Reacting force Q: At max. capacity rating = **187 kN max.**

Rod return: Nitrogen accumulator (0.55 bar to 1.03 bar) combined with return spring

Dimensions and Capacity Chart

Type	Stroke mm	A max	B	C	Max. Energy Capacity W ₃ Nm/Cycle	1 Effective Weight me		Min. Return Force N	Max. Return Force N	Max. Side Load Angle °	Weight kg
						me min. kg	me max. kg				
EB63-100EU	100	420	288	192	16 000	900	128 000	700	6 900	3.5	13.7
EB63-200EU	200	700	468	292	32 000	1 800	256 000	770	9 300	3	16.7
EB63-300EU	300	980	648	392	48 000	2 700	384 000	830	10 600	2.5	21.8
EB63-400EU	400	1 260	828	492	64 000	3 700	512 000	600	11 100	2	25.8
EB63-500EU	500	1 540	1 008	592	80 000	4 700	640 000	670	12 000	1.5	29.8

¹ The correct effective weight range for your application will be calculated by ACE and should fall within this band.

Special options: Special oils, special flanges, additional corrosion protection etc. available on request.

Front Flange -F

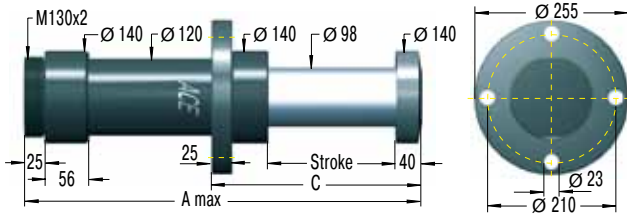

Rear Flange -R

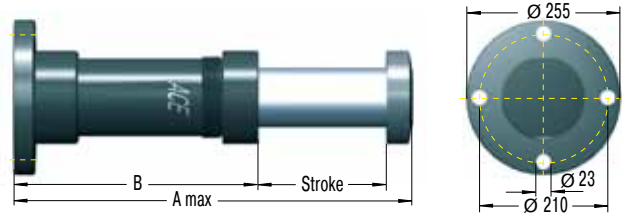

80

Ordering Example

Safety Shock Absorber _____
 Bore Size Ø 100 mm _____
 Stroke 400 mm _____
 EU Compliant _____
 Mounting Style: Front Flange _____
 Identification No. assigned by ACE _____

EB100-400EU-F-X

Please indicate identification no. in case of replacement order

Complete Details Required when Ordering

Moving load m (kg)
 Impact velocity range v (m/s)max.
 Creep speed vs (m/s)
 Motor power P (kW)
 Stall torque factor ST (normal 2.5)
 Number of absorbers in parallel n

or technical data according to formulae and calculations on page 15 to 17.

The calculation and selection of the correct ACE safety shock absorber for your application should be referred to ACE for approval and assignment of unique identification number.

Technical Data

Reacting force Q: At max. capacity rating = **467 kN max.**

Rod return: Nitrogen accumulator (0.55 bar to 1.03 bar) combined with return spring

Dimensions and Capacity Chart

Type	Stroke mm	A max	B	C	Max. Energy Capacity W ₃ Nm/Cycle	1 Effective Weight me		Min. Return Force N	Max. Return Force N	Max. Side Load Angle °	Weight kg
						me min. kg	me max. kg				
EB100-200EU	200	735	495	320	80 000	6 900	640 000	1 200	8 900	4	43.5
EB100-300EU	300	1 005	665	420	120 000	10 300	960 000	950	14 100	3.5	51.8
EB100-400EU	400	1 275	835	520	160 000	13 800	1 280 000	1 190	18 200	3	60.1
EB100-500EU	500	1 545	1 005	620	200 000	17 200	1 600 000	930	20 800	2.5	68.5
EB100-600EU	600	1 815	1 175	720	240 000	20 700	1 920 000	1 170	23 300	2	76.8

¹ The correct effective weight range for your application will be calculated by ACE and should fall within this band.

Special options: Special oils, special flanges, additional corrosion protection etc. available on request.

Front Flange -F

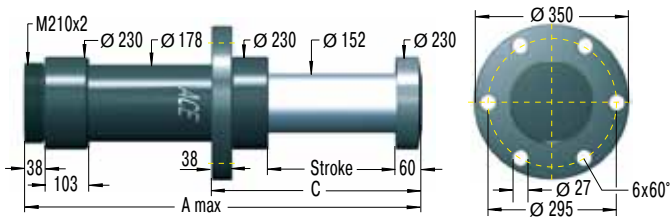

Rear Flange -R

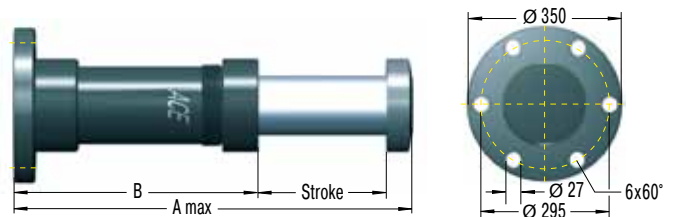

Ordering Example

Safety Shock Absorber _____
 Bore Size Ø 160 mm _____
 Stroke 400 mm _____
 EU Compliant _____
 Mounting Style: Front Flange _____
 Identification No. assigned by ACE _____

EB160-400EU-F-X

Please indicate identification no. in case of replacement order

Complete Details Required when Ordering

Moving load m (kg)
 Impact velocity range v (m/s)max.
 Creep speed vs (m/s)
 Motor power P (kW)
 Stall torque factor ST (normal 2.5)
 Number of absorbers in parallel n

or technical data according to formulae and calculations on page 15 to 17.

Technical Data

Reacting force Q: At max. capacity rating = **700 kN max.**

Rod return: Nitrogen accumulator (0.55 bar to 1.03 bar) combined with return spring

Dimensions and Capacity Chart

Type	Stroke mm	A max	B	C	Max. Energy Capacity W ₃ Nm/Cycle	1 Effective Weight me		Min. Return Force N	Max. Return Force N	Max. Side Load Angle °	Weight kg
						me min. kg	me max. kg				
EB160-400EU	400	1 400	940	600	240 000	22 700	1 920 000	1 870	18 100	4	155.6
EB160-600EU	600	2 000	1 340	800	360 000	34 000	2 880 000	2 100	18 800	3	189
EB160-800EU	800	2 600	1 740	1 000	480 000	45 400	3 840 000	2 400	19 500	2	222.3

¹ The correct effective weight range for your application will be calculated by ACE and should fall within this band.

Special options: Special oils, special flanges, additional corrosion protection etc. available on request.

Permitted Use

ACE safety shock absorbers are machine elements to brake moving masses in a defined end position in emergency stop situations for axial forces. The safety shock absorbers are not designed for regular operational usage.

Calculation of safety shock absorbers

The calculation of safety shock absorbers should generally be performed or checked by ACE.

Deceleration Properties

The orifice sizing and drill pattern in the pressure chamber are individually designed for each safety shock absorber. The respective absorption characteristic is optimised corresponding to the maximum mass that occurs in the emergency stop and the impact speed. Correspondingly, each safety shock absorber is given an individual identification number.

Model Code

For types SCS33 to 64, the individual five-digit identification numbers can be taken from the last digits of the shock absorber model code shown on the label. Example: SCS33-50EUM-1XXXX. For type series SCS38 to SCS63, CB63 to CB160 and EB63 to EB160, the identification number is a five digit number. Example: SCS38-100EU-F-XXXXX. In addition to the model code, the label also shows the authorised maximum impact velocity and maximum authorised impact mass for the unit.

Mounting

To mount the shock absorber, we recommend the use of original ACE mounting accessories shown in catalogue. The mounting of each shock absorber must be exactly positioned so that the reaction force (Q) can be adequately transmitted into the mounting structure. ACE recommends installation via the front flange -F mounting style that ensures the maximum protection against buckling. The damper must be mounted so that the moving loads are decelerated with the least possible side loading to the piston rod. The maximum permissible side load angles are detailed in our current catalogue. The entire stroke length must be used for deceleration because only using part of the stroke can lead to overstressing and damage to the unit.

Mounting style front flange -F



Safety Shock Absorber SCS

Safety Shock Absorber CB

Environmental Requirements

The permissible temperature range for each shock absorber type can be found in our current catalogue.

CAUTION: Usage outside the specified temperature range can lead to premature breakdown and damage of the shock absorbers which can then result in severe system damage or machine failures.

Trouble free operation outdoors or in damp environments is only warranted if the dampers are coated with a specific corrosion protection finish.

Initial Start-Up Checks

First impacts on the shock absorber should only be tried after correctly mounting and with reduced impact speeds and – if possible – with reduced load. Differences between calculated and actual operating data can then be detected early on, and damage to your system can be avoided. If the shock absorbers were selected on calculated data that does not correspond to the maximum possible loading (i.e. selection based on drive power being switched off or at reduced impact speed) then these restricted impact conditions must not be exceeded during initial testing or subsequent use of the system. Otherwise you risk damaging the shock absorbers and/or your machine by overstressing materials. After the initial trial check that the piston rod fully extends again and that there are no signs of oil leakage. Also check that the mounting hardware is still securely tightened. You need to satisfy yourself that no damage has occurred to the piston rod, the body, or the mounting hardware.

Fixed Mechanical Stop

Safety shock absorbers do not need an external stop as a stroke limiter. The stroke of the safety absorber is limited by the stop of the impact head on the shock absorber. For types SCS33 to SCS64, the fixed stop point is achieved with the integrated stop collar.

What Needs to be Checked after a Full Load Impact?

Safety shock absorbers that were originally checked only at reduced speed or load need to be checked again after a full load impact (i.e. emergency use) has occurred. Check that the piston rod fully extends to its full out position, that there are no signs of oil leakage and that the mounting hardware is still securely fixed. You need to satisfy yourself that no damage has occurred to the piston rod, the body, or the mounting hardware. If no damage has occurred, the safety shock absorber can be put back into normal operation (see **initial start-up**).

Maintenance

Safety shock absorbers are sealed systems and do not need special maintenance. Safety shock absorbers that are not used regularly (i.e. that are intended for emergency stop systems) should be checked within the normal time frame for safety checks, but **at least once a year**. At this time special attention must be paid to checking that the piston rod resets to its fully extended position, that there is no oil leakage and that the mounting brackets are still secure and undamaged. The piston rod must not show any signs of damage. Safety shock absorbers that are **in use regularly** should be checked **every three months**.

Repair Notice

If any damage to the shock absorber is detected or if there are any doubts as to the proper functioning of the unit please send the unit for service to ACE. Alternatively contact your local ACE office for further advice.

Detailed information on the above listed points can be taken from the corresponding operating and assembly instructions.

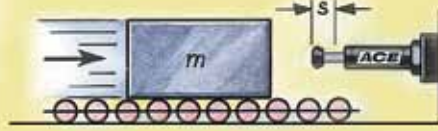

Controlled emergency stop

ACE safety shock absorbers protect precision assembly jigs for the aircraft industry.

The basic mount of this coordinate measuring machine for the production of parts in the aircraft industry is made of granite and must not be damaged. To avoid damage from operating errors or mishandling, all movement axes were equipped with safety shock absorbers of the type **SCS45-50EU**.

If the turntables malfunction the safety shock absorbers decelerate the loads before expensive damage can occur to the granite measuring tables.



Optimally protected turntable

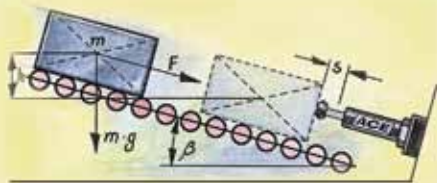

Downhill security

ACE safety shock absorbers defy the forces of nature.

In order to efficiently protect against falling rocks, a net is put through its paces under realistic conditions. Large sized **SCS80-500EU-F** type safety shock absorbers with additional crash sleeves safeguard the high durability of the test construction. These models provide the necessary reserves for energy absorption – especially with regard to the supporting forces which must be considered during the very high collision speed imposed on a stone transportation car.



Complete protection on a test facility